

NRSA Series

SMD Power Inductors For Automotive

Size 8040

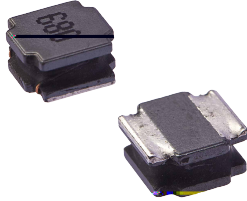

FEATURES

- Magnetic shield type wound inductor for power circuits using a ferrite magnetic material
- High magnetic shield construction and compatible with high-density mounting
- Larger current and lower Rdc were achieved by optimizing the ferrite core figure.
- Operating temperature: -55 to +125°C (including self-temperature rise)
- AEC-Q200 qualified
- Quantity: 1000pcs

APPLICATION

- Car navigation, car stereo and car accessories only

Dimensions: [mm]

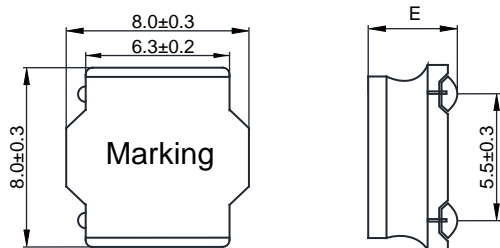

Land Pattern: [mm]

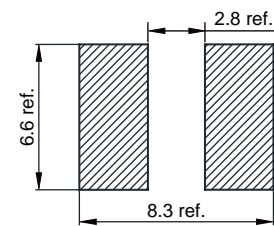

Electrical Properties:

Part No	Inductance @100KHz/1V (μH)	Tolerance	Saturation Current Typ. (A)	Saturation Current Max. (A)	Temperature Rise Current Typ. (A)	Temperature Rise Current Max. (A)	DC Resistance ±20% (mΩ)	SRF Min. (MHZ)	E
NRSA8040-1R0M	1.0	±20%	13.8	13.0	8.50	8.00	8.20	92	4.2 Max
NRSA8040-1R4M	1.4	±20%	11.8	11.2	8.20	7.80	10.0	78	4.2 Max
NRSA8040-1R5M	1.5	±20%	11.5	11.0	8.00	7.70	10.0	70	4.2 Max
NRSA8040-2R2M	2.2	±20%	9.80	9.20	7.40	6.90	11.5	61	4.2 Max
NRSA8040-3R3M	3.3	±20%	8.00	7.50	6.60	6.20	15.0	30	4.2 Max
NRSA8040-4R7M	4.7	±20%	6.70	6.00	5.80	5.30	19.5	23	4.2 Max
NRSA8040-5R6M	5.6	±20%	6.20	5.80	5.40	5.20	22.0	21	4.2 Max
NRSA8040-6R8M	6.8	±20%	5.60	5.10	5.10	5.00	25.0	23	4.2 Max
NRSA8040-8R2M	8.2	±20%	5.30	4.60	4.80	4.50	30.0	16	4.2 Max
NRSA8040-100M	10	±20%	5.00	4.30	4.60	4.20	33.0	15	4.2 Max
NRSA8040-150M	15	±20%	4.00	3.60	3.60	3.20	50.0	12	3.7±0.3
NRSA8040-220M	22	±20%	3.10	2.80	2.90	2.45	73.0	8.0	3.7±0.3
NRSA8040-330M	33	±20%	2.60	2.10	2.30	2.10	100	7.0	3.7±0.3
NRSA8040-470M	47	±20%	2.20	1.90	2.00	1.70	135	7.3	3.7±0.3
NRSA8040-560M	56	±20%	1.90	1.60	1.72	1.60	160	7.0	3.7±0.3
NRSA8040-680M	68	±20%	1.75	1.50	1.65	1.50	205	6.3	3.7±0.3
NRSA8040-820M	82	±20%	1.60	1.40	1.40	1.30	230	5.8	3.7±0.3

NRSA8040-101M						
NRSA8040-151M						
NRSA8040-221M						

I_R will cause the coil temperature rise approximately $\pm 40^\circ\text{C}$
 I_{SAT} will cause L to drop approximately 30%.

Typical Electrical Characteristics:

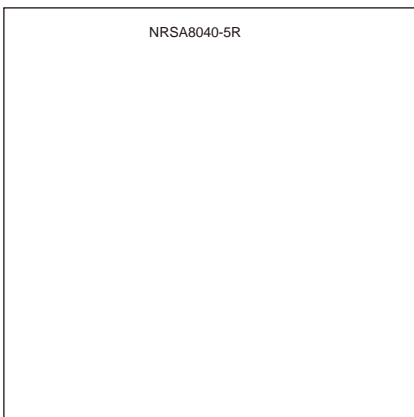
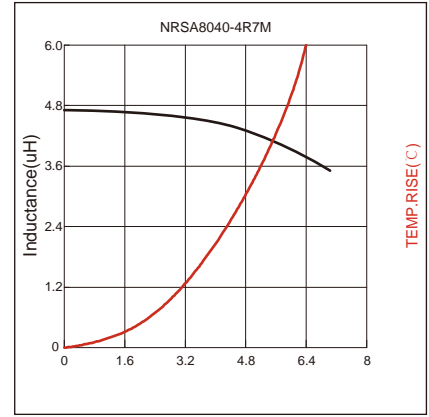
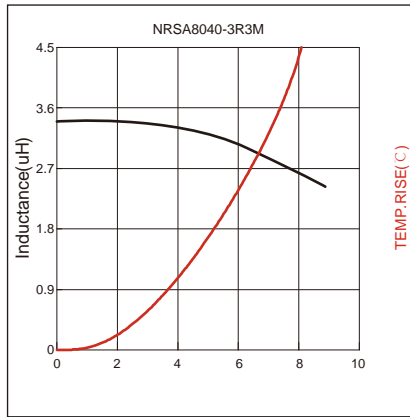
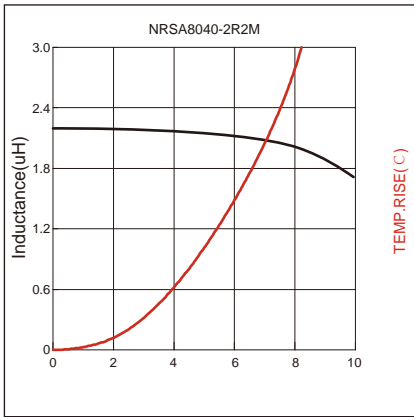
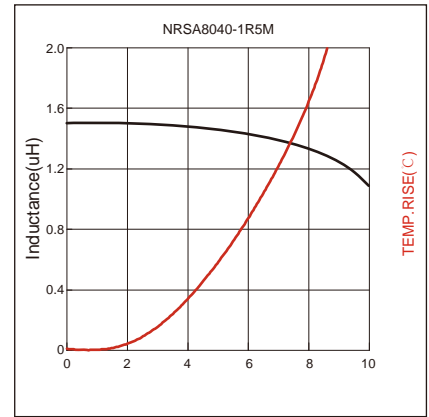
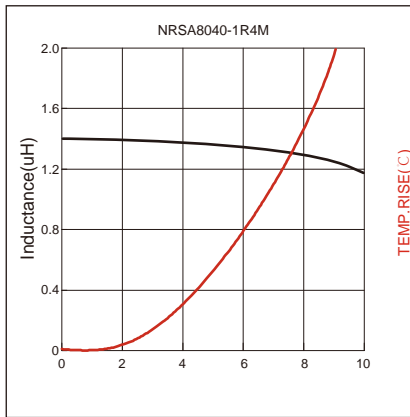
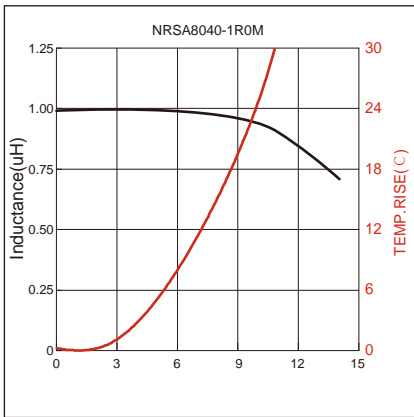

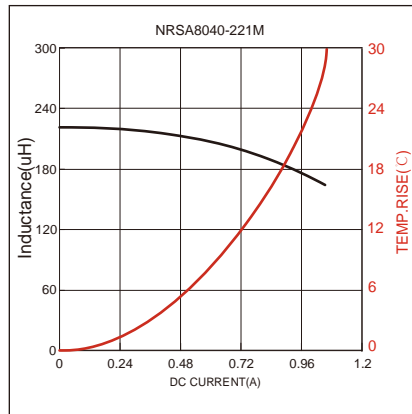
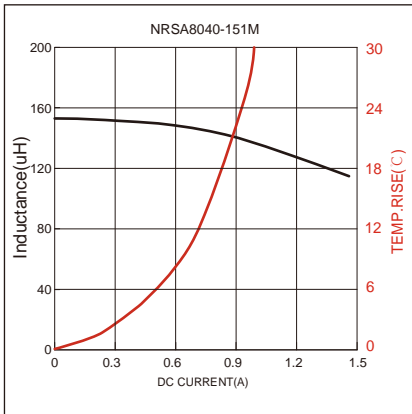
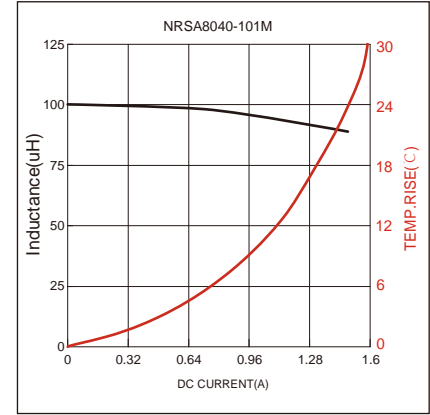
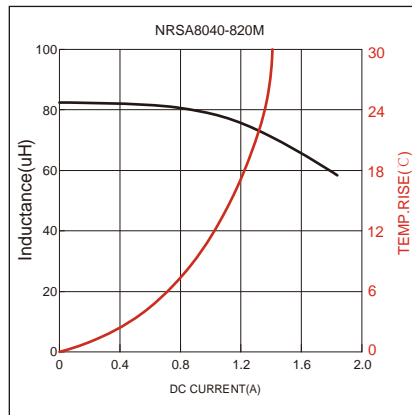
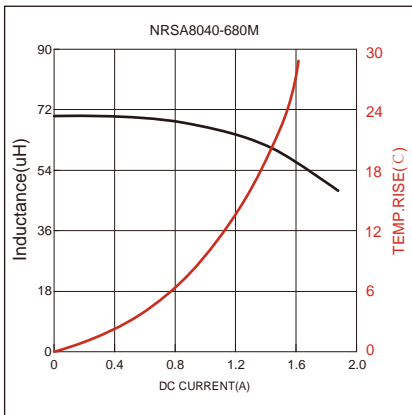
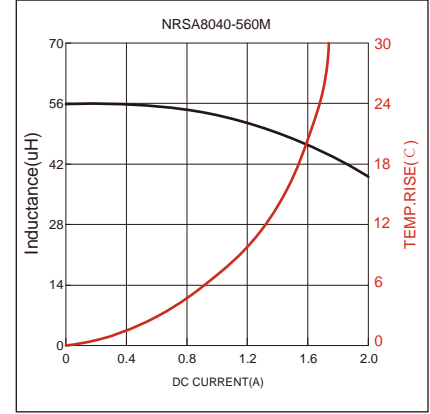
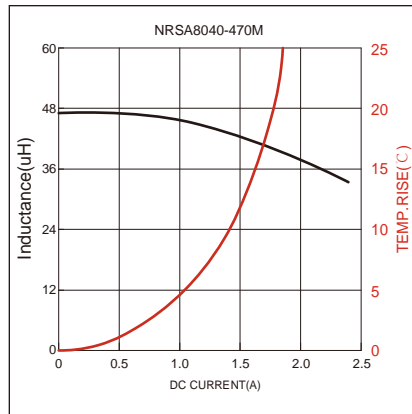
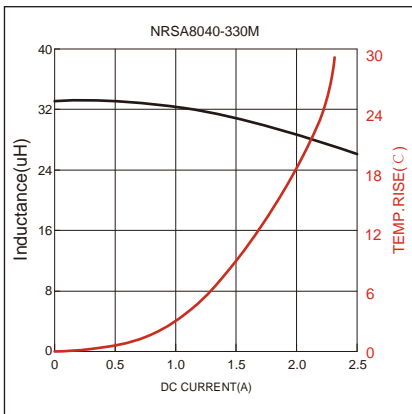
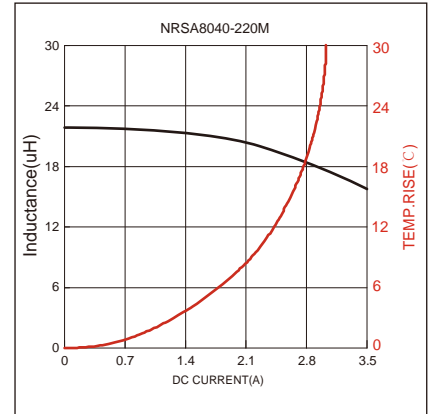
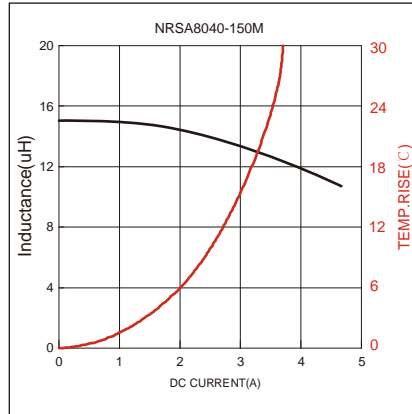
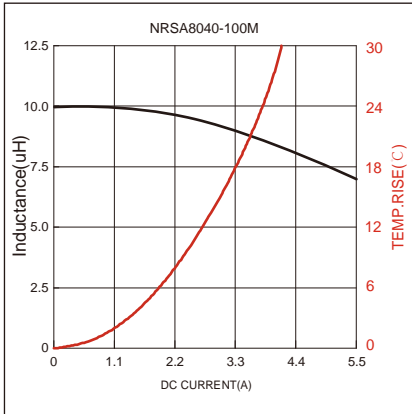

Soldering Reflow:

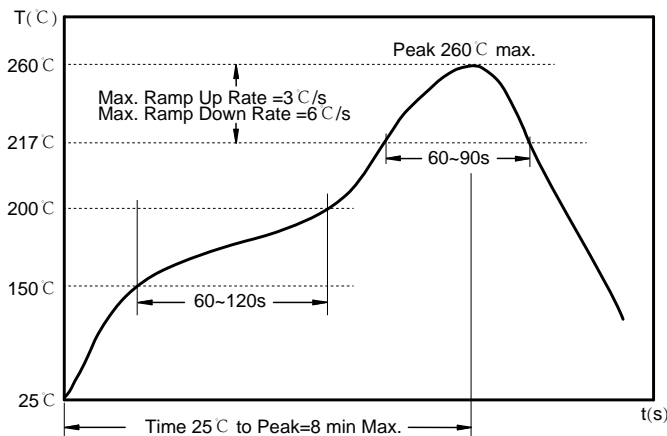

Preheat condition: 150 ~200 °C / 60~120 sec.

Allowed time above 217 °C : 60~90 sec.

Max temperature: 260 °C .

Allowed Reflow time: 2x max.

Packaging Information:

Tape Dimension :

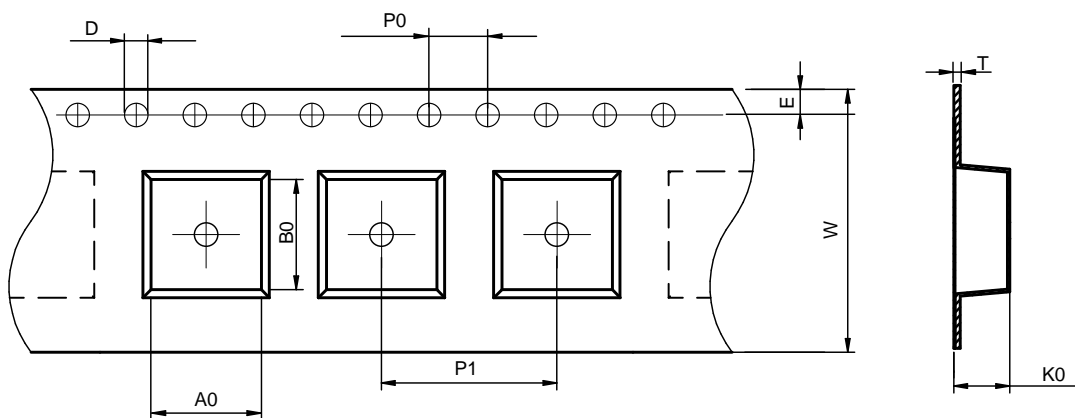

Series	A0 (mm)	B0 (mm)	D (mm)	P0 (mm)	P1 (mm)	W (mm)	K0 (mm)	E (mm)	T (mm)
NRSA8040	8.55±0.1	8.55±0.1	1.5±0.1	4.0±0.1	12.0±0.1	16.0±0.3	4.4±0.1	1.75±0.1	0.40±0.05

Peel force of top cover tape:

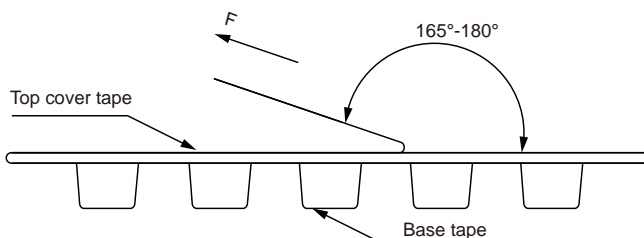

The peel force of top cover tape shall be between 0.3 to 1.17 N

Product Marking:

Marking	Printing (Inductance)
---------	-----------------------

Reel Dimension: [mm]

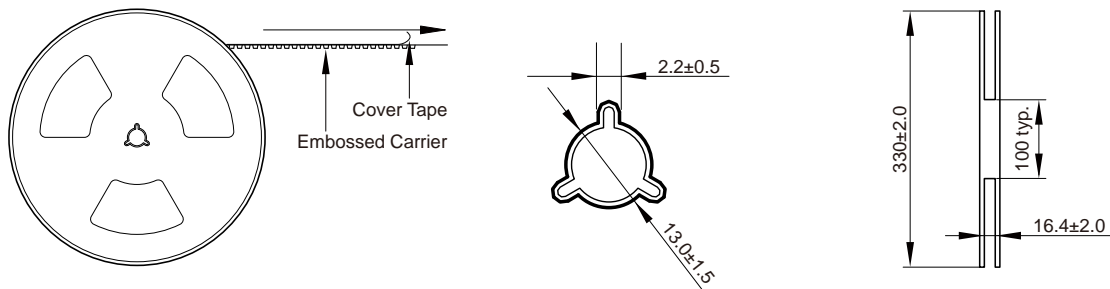

Packaging Quantity:

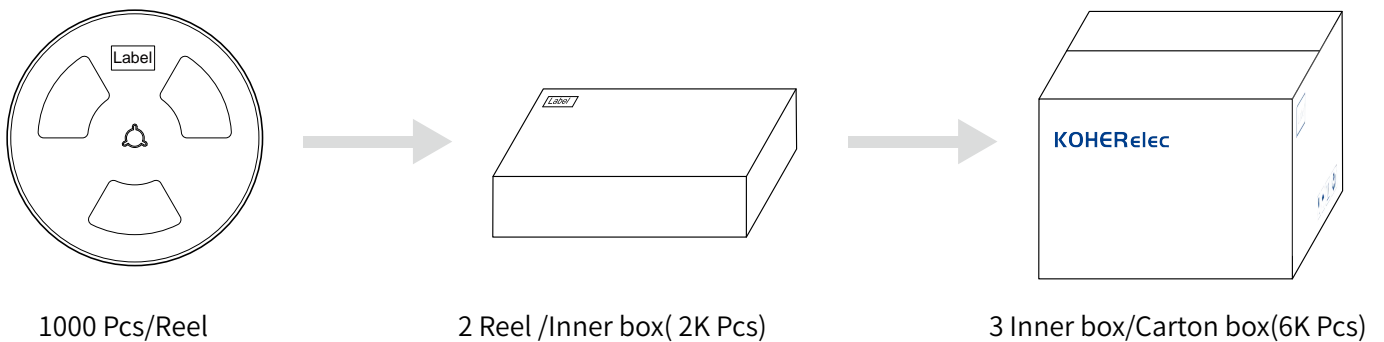

Cautions and Warnings:

Storage Conditions :

- The storage period is within 12 months after the completion of production. Be sure to follow the storage conditions (temperature: -5 to 35°C, humidity: 75% RH Max). If the storage period elapses, the soldering of the terminal electrodes may deteriorate. The warranty period is one year.
- Product should not be exposed to environment with high temperature, high humidity, dust, corrosive gas and etc.
- Products should be handled with care to avoid damage or contamination from perspiration and skin oils.
- Please always handle products carefully to prevent any damage caused by dropping down or inappropriate removing.

Operation Instructions:

- Self heating (temperature increase) occurs when the power is turned ON, so the tolerance should be sufficient for the set thermal design.
- Before soldering, be sure to preheat components. The preheating temperature should be set so that the temperature difference between the solder temperature and chip temperature does not exceed 150°C.
- Soldering corrections after mounting should be within the range of the conditions determined in the specifications. If overheated, a short circuit, performance deterioration, or lifespan shortening may occur.
- Generally, Koher might not be familiar with either customer's specific application or actual requests as customer does. As a result customer shall be responsible for checking and confirming whether Koher product with the performance described in the product specification is suitable for using in customer's particular application or not.