

## SMD Power Inductors For Automotive Size 4014B

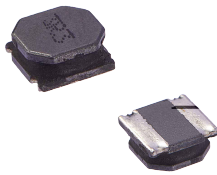

- Magnetic shield type wound inductor for power circuits using a ferrite magnetic material
- High magnetic shield construction and compatible with high-density mounting.
- 
- 
- 
- Quantity: 4500pcs
- Car navigation, car stereo and car accessories only

### Dimensions: [mm]

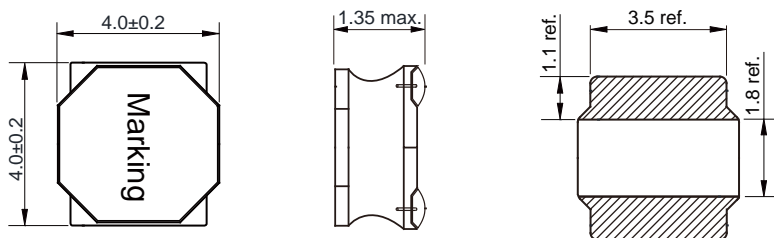

### Land Pattern: [mm]

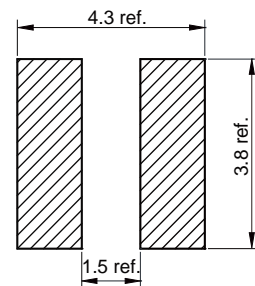

### Electrical Properties:

Part No	Inductance @100KHz/1V (µH)	Tolerance	Temperature Rise Current Typ. (A)	Saturation Current Typ. (A)	DC Resistance ±20% (mΩ)
NRSA4014B-1R0N	1.0	±30%	2.20	2.80	45
NRSA4014B-2R2M	2.2	±20%	1.90	1.65	75
NRSA4014B-3R3M	3.3	±20%	1.70	1.40	108
NRSA4014B-4R7M	4.7	±20%	1.50	1.20	108

Saturation Current will cause L to drop approximately 30%

Temperature Rise Current: The actual value of DC current when the temperature rise is  $\Delta T=40^{\circ}\text{C}$

# Typical Electrical Characteristics:

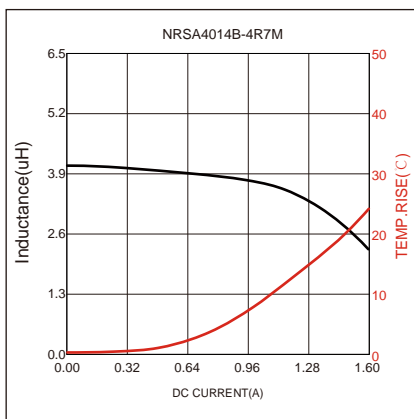
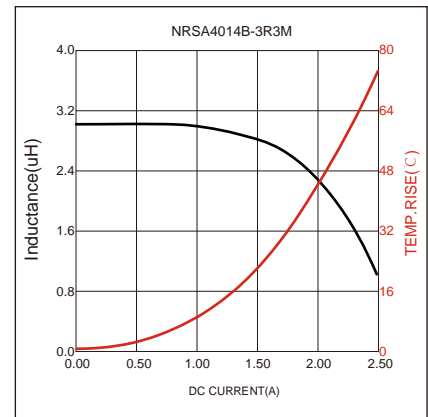
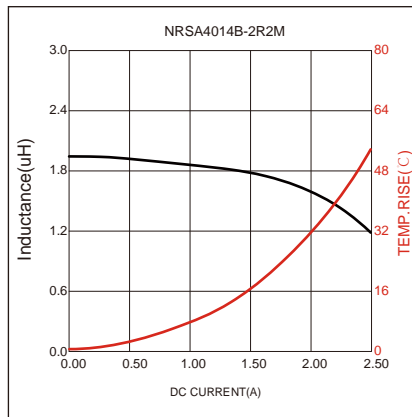
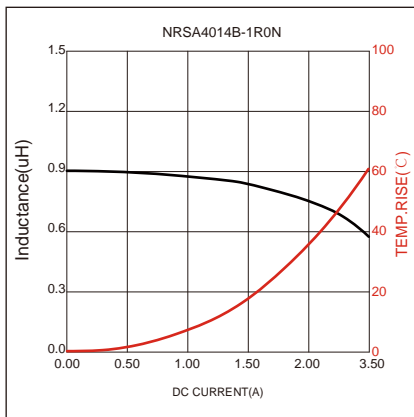

## Soldering Reflow:

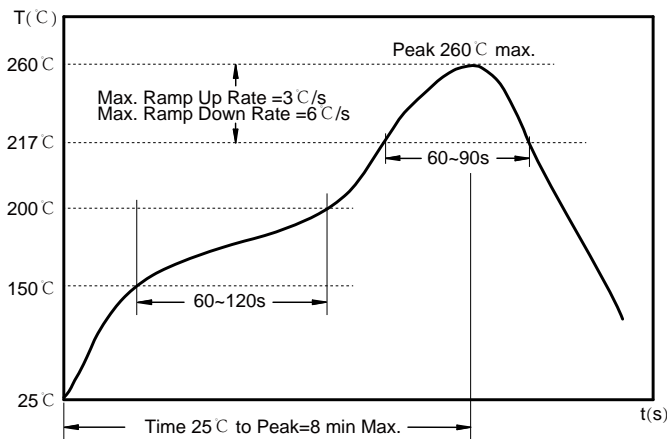

Preheat condition: 150 ~200°C / 60~120 sec.

Allowed time above 217°C : 60~90 sec.

Max temperature: 260°C .

Allowed Reflow time: 2x max.

## Packaging Information:

### Tape Dimension :

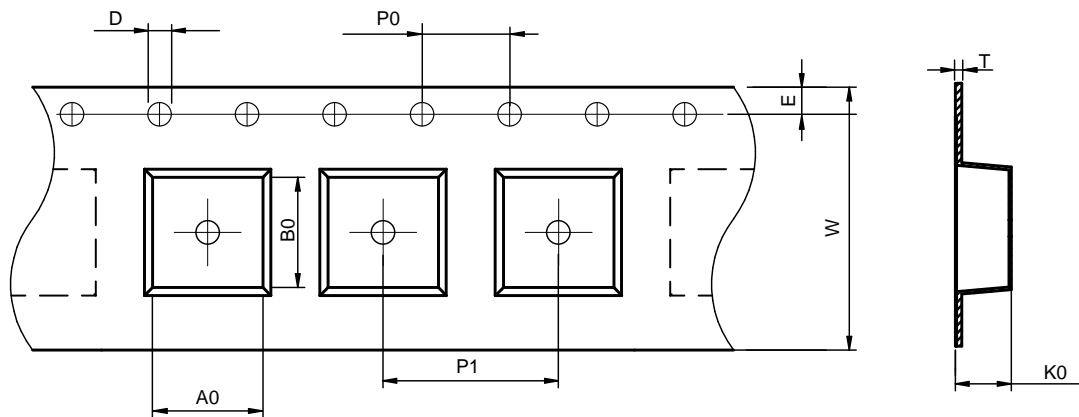

Series	A0 (mm)	B0 (mm)	D (mm)	P0 (mm)	P1 (mm)	W (mm)	K0 (mm)	E (mm)	T (mm)
NRSA4014B	4.25±0.1	4.25±0.1	1.5±0.1	4.0±0.1	8.0±0.1	12.0±0.3	1.4±0.1	1.75±0.1	0.30±0.05

### Peel force of top cover tape:

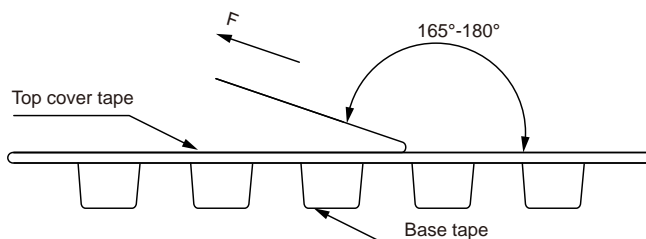

The peel force of top cover tape shall be between 0.3 to 1.17 N

### Product Marking:

Marking	Printing (Inductance)
---------	-----------------------

## Reel Dimension: [mm]

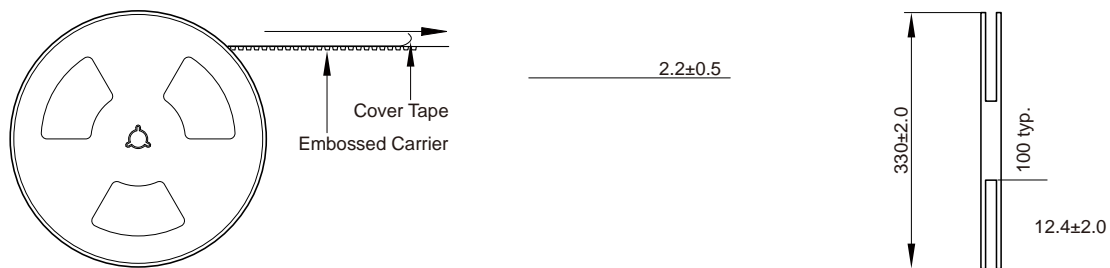

## Packaging Quantity:

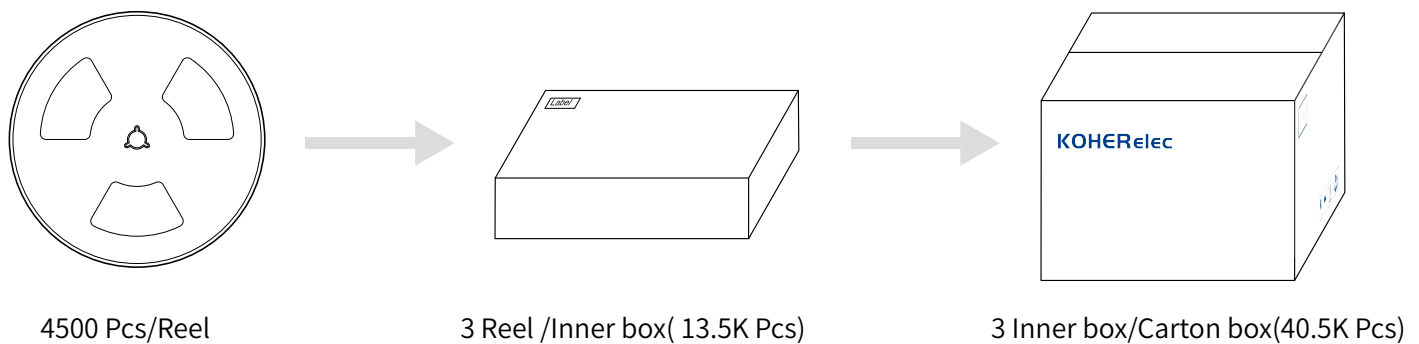

## Cautions and Warnings:

### Storage Conditions :

- The storage period is within 12 months after the completion of production. Be sure to follow the storage conditions (temperature: -5 to 35°C, humidity: 75% RH Max).If the storage period elapses, the soldering of the terminal electrodes may deteriorate.The warranty period is one year.
- Product should not be exposed to environment with high temperature, high humidity, dust, corrosive gas and etc.
- Products should be handled with care to avoid damage or contamination from perspiration and skin oils.
- Please always handle products carefully to prevent any damage caused by dropping down or inappropriate removing.

### Operation Instructions:

- Self heating (temperature increase) occurs when the power is turned ON, so the tolerance should be sufficient for the set thermal design.
- Before soldering, be sure to preheat components.The preheating temperature should be set so that the temperature difference between the solder temperature and chip temperature does not exceed 150°C.
- Soldering corrections after mounting should be within the range of the conditions determined in the specifications.If overheated, a short circuit, performance deterioration, or lifespan shortening may occur.
- Generally, Koher might not be familiar with either customer's specific application or actual requests as customer does.As a result customer shall be responsible for checking and confirming whether Koher product with the performance described in the product specification is suitable for using in customer's particular application or not.