

-
-
-
-
-
-
-

-
-



Part No	Inductance @ 100KHz/1V	Tolerance	Temperature Rise Current Max.	Current Max.	DC Resistance Typ.	DC Resistance Max.

△

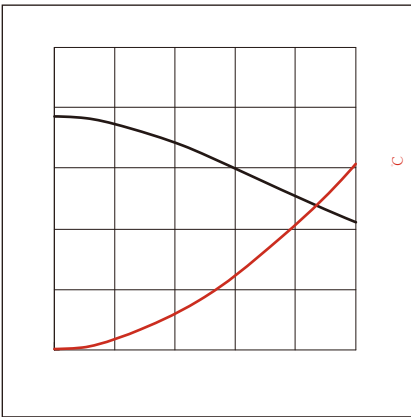
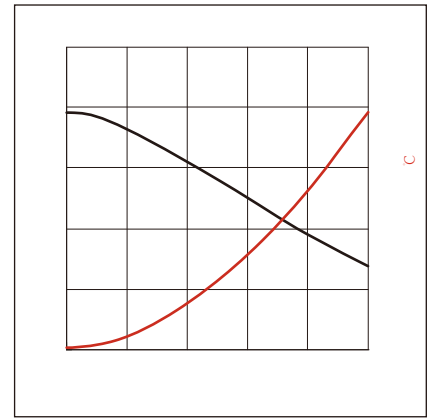
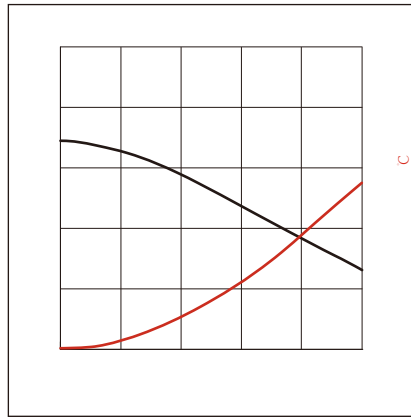
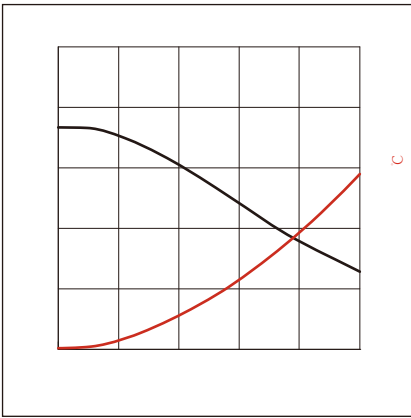
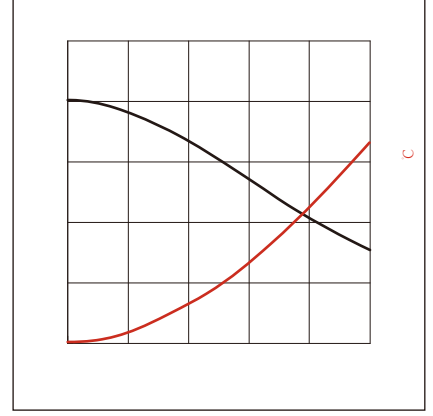
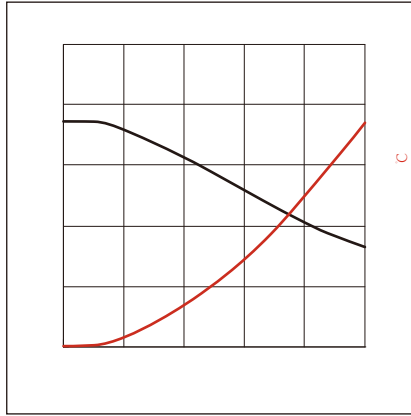
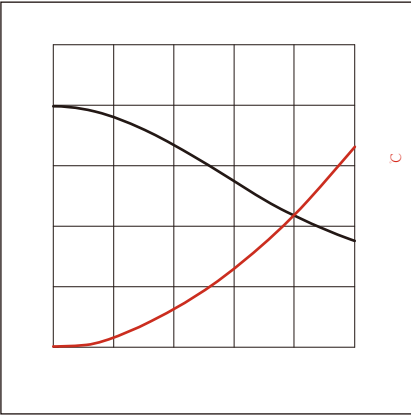

C
C
C

:

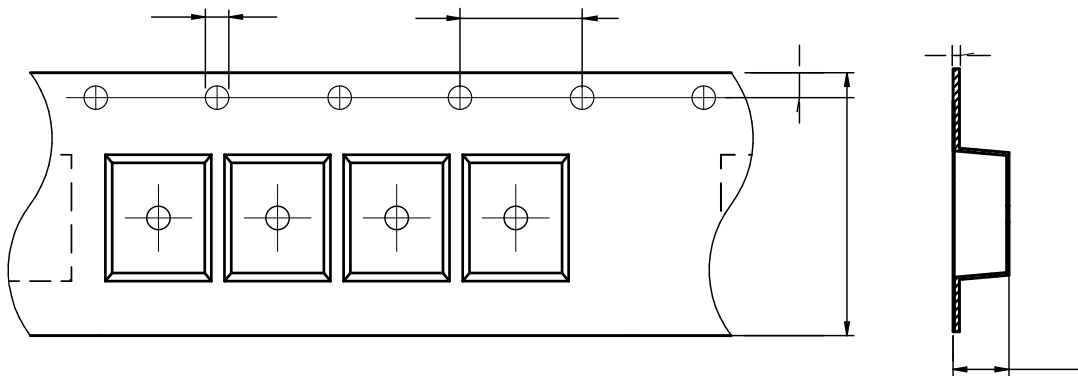

NRSA3015	3.4 ± 0.1	3.4 ± 0.1	1.5 ± 0.1	4.0 ± 0.1	4.0 ± 0.1	8.0 ± 0.3	1.7 ± 0.1	1.75 ± 0.1	0.23 ± 0.1

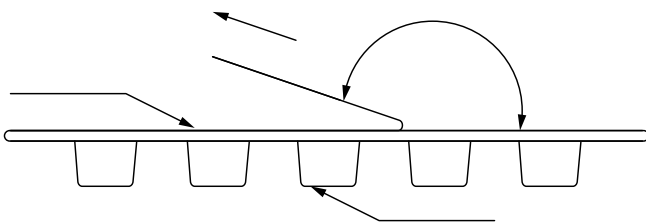

The peel force of top cover tape shall be between 0.1 to 0.98 N

:

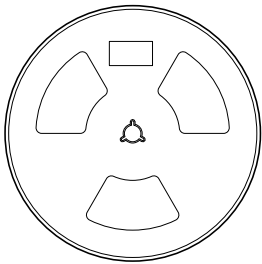
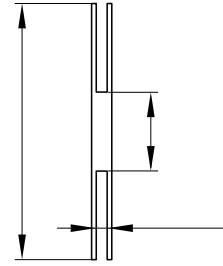
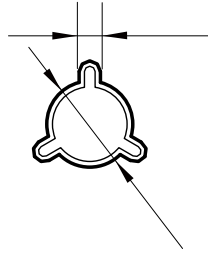
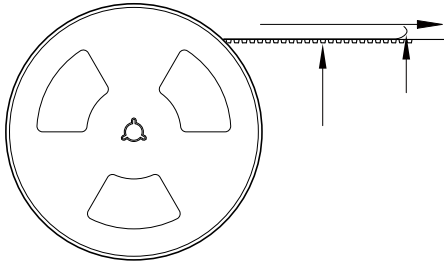

2000 Pcs/Reel

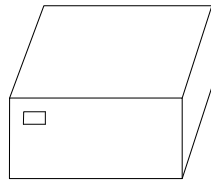

5 Reel /Inner box(10K Pcs)

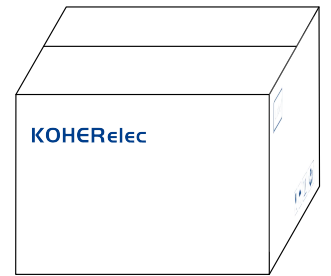

8 Inner box/Carton box(80K Pcs)

:

-
-
-
-
-
-
-
-
-