

NRSA Series

SMD Power Inductors For Automotive

Size 2520B



FEATURES

- Magnetic shield type wound inductor for power circuits using a ferrite magnetic material
- High magnetic shield construction and compatible with high-density mounting.
- Larger current and lower Rdc were achieved by optimizing the ferrite core figure.
- Operating temperature: -55 to +125°C(including self-temperature rise)
- AEC-Q200 qualified
- Quantity: 2000pcs

APPLICATION

- Car navigation, car stereo and car accessories only

Dimensions: [mm]

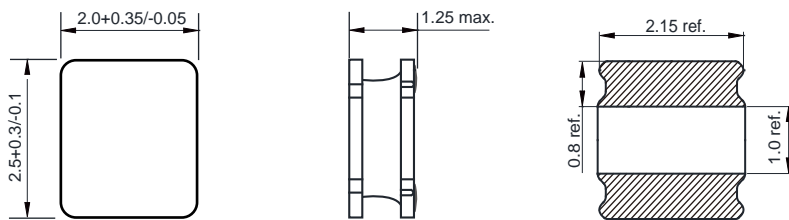

Land Pattern: [mm]

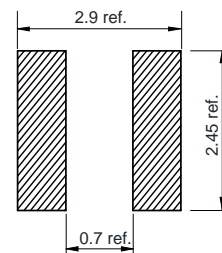

Electrical Properties:

	(μH)		(A)	Saturation (A)	(m Ω)
NRSA2520B-R24N	0.24	$\pm 30\%$	3.50	4.05	28
NRSA2520B-R33N	0.33	$\pm 30\%$	3.00	4.00	40
NRSA2520B-R47N	0.47	$\pm 30\%$	2.90	3.60	40
NRSA2520B-R56N	0.56	$\pm 30\%$	2.80	3.30	40
NRSA2520B-R68N	0.68	$\pm 30\%$	2.60	3.28	45
NRSA2520B-1R0M	1.00	$\pm 20\%$	2.40	2.45	60
NRSA2520B-1R5M	1.50	$\pm 20\%$	1.90	2.05	84
NRSA2520B-2R2M	2.20	$\pm 20\%$	1.80	1.90	110
NRSA2520B-3R3M	3.30	$\pm 20\%$	1.40	1.50	155
NRSA2520B-4R7M	4.70	$\pm 20\%$	1.20	1.35	228
NRSA2520B-6R8M	6.80	$\pm 20\%$	0.90	1.00	325
NRSA2520B-100M	10.0	$\pm 20\%$	0.75	0.79	480
NRSA2520B-150M	15.0	$\pm 20\%$	0.55	0.65	625
NRSA2520B-180M	18.0	$\pm 20\%$	0.50	0.55	1000
NRSA2520B-220M	22.0	$\pm 20\%$	0.45	0.50	1020
NRSA2520B-330M	33.0	$\pm 20\%$	0.37	0.38	1400
NRSA2520B-470M	47.0	$\pm 20\%$	0.29	0.30	2000

Saturation Current will cause L to drop approximately 30%

Temperature Rise Current: The actual value of DC current when the temperature rise is $\Delta T=40^\circ\text{C}$

Typical Electrical Characteristics:

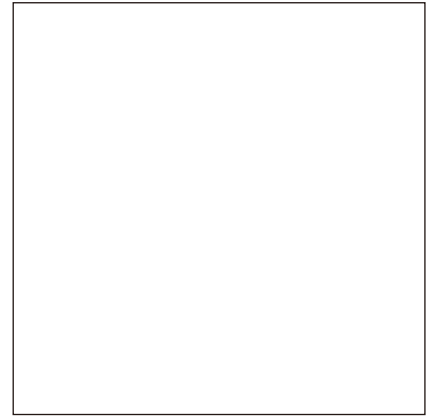
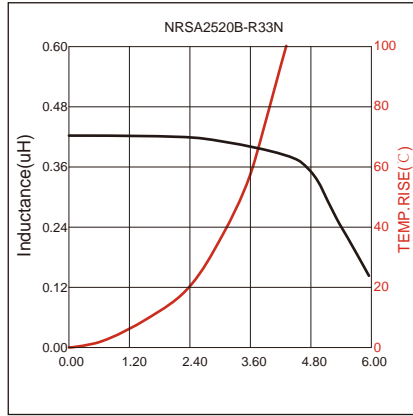
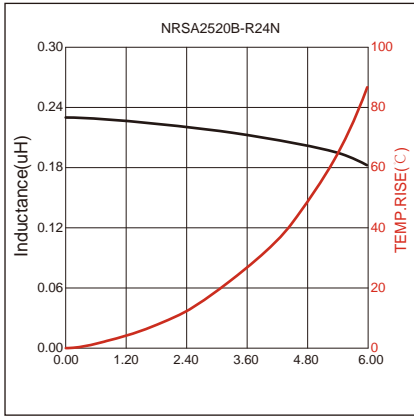

2.0
1.6
1.2
0.8
0.4
0.0

Inductance(uH)

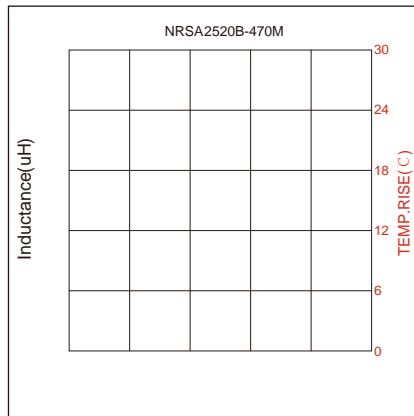
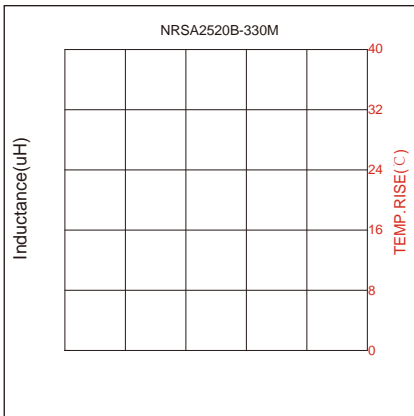
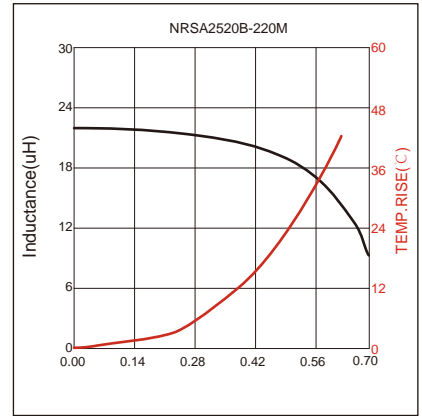
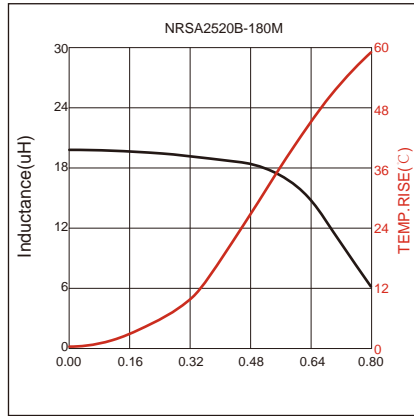
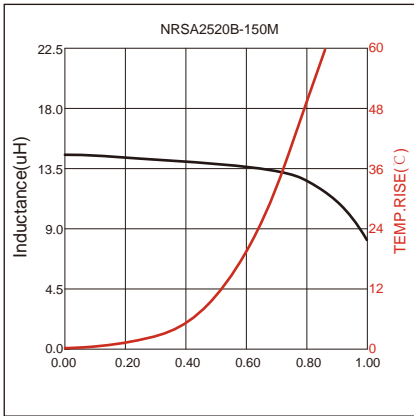

Soldering Reflow:

Packaging Information:

Tape Dimension:

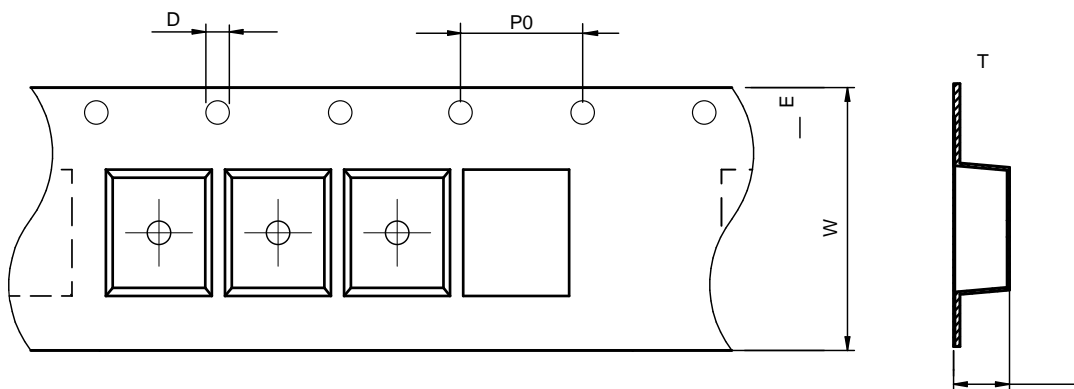

Series	A0 (mm)	B0 (mm)	D (mm)	P0 (mm)	P1 (mm)	W (mm)	K0 (mm)	E (mm)	T (mm)
NRSA2520B	2.4±0.1	3.0±0.1	1.5±0.1	4.0±0.1	4.0±0.1	8.0±0.1	1.4±0.1	1.75±0.1	0.20±0.05

Peel force of top cover tape:

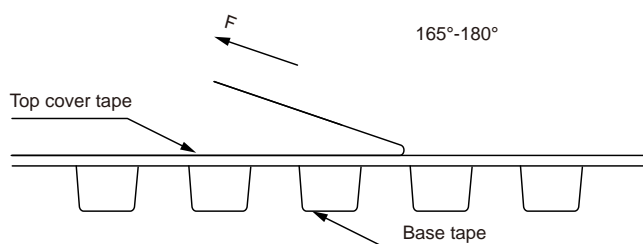

The peel force of top cover tape shall be between 0.2 to 0.58 N

Reel Dimension: [mm]

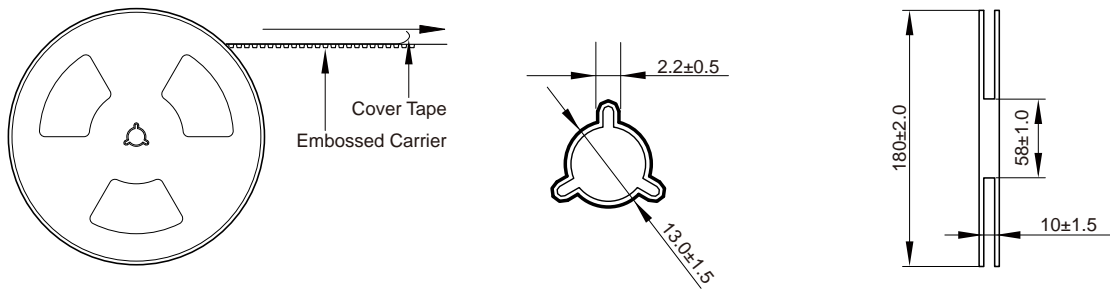

Packaging Quantity:

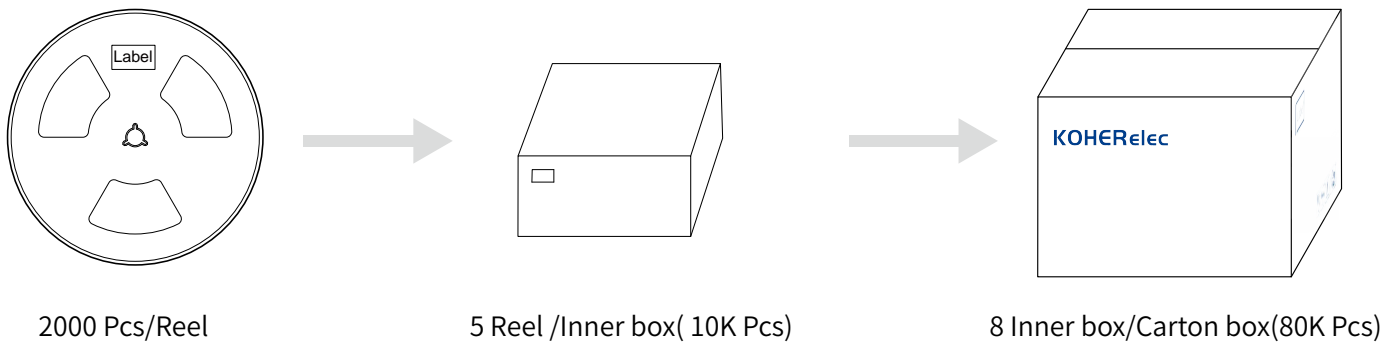

Cautions and Warnings:

Storage Conditions :

- The storage period is within 12 months after the completion of production. Be sure to follow the storage conditions (temperature: -5 to 35°C, humidity: 75% RH Max).If the storage period elapses, the soldering of the terminal electrodes may deteriorate.The warranty period is one year.
- Product should not be exposed to environment with high temperature, high humidity, dust, corrosive gas and etc.
- Products should be handled with care to avoid damage or contamination from perspiration and skin oils.
- Please always handle products carefully to prevent any damage caused by dropping down or inappropriate removing.

Operation Instructions:

- Self heating (temperature increase) occurs when the power is turned ON, so the tolerance should be sufficient for the set thermal design.
- Before soldering, be sure to preheat components.The preheating temperature should be set so that the temperature difference between the solder temperature and chip temperature does not exceed 150°C.
- Soldering corrections after mounting should be within the range of the conditions determined in the specifications.If overheated, a short circuit, performance deterioration, or lifespan shortening may occur.
- Generally, Koher might not be familiar with either customer's specific application or actual requests as customer does.As a result customer shall be responsible for checking and confirming whether Koher product with the performance described in the product specification is suitable for using in customer's particular application or not.