

MDTE Series

Wire Wound Molded SMD Power Inductors

Size 1513

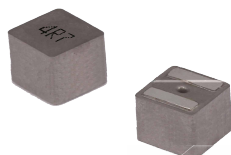

FEATURES

- So saturation
- High current, low DCR, high efficiency
- Very low acoustic noise and very low leakage flux noise
- High reliability
- 100% Lead (Pb)-Free and RoHS compliant
- Operating temperature -55~+125°C (Including self-temperature rise)
- Quantity: 100pcs

APPLICATION

- Note PC power system, incl. IMVP-6
- DC/DC converter

Dimensions: [mm]

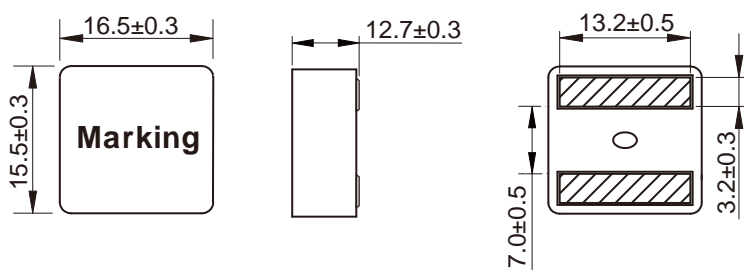

Land Pattern: [mm]

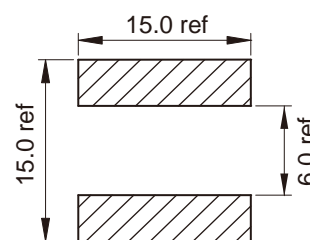

Electrical Properties:

	(μH)		Saturation (A)	Saturation (A)	(A)	(m Ω)
MDTE1513-4R7M	4.7	±20%	44.0	40.0	31.0	3.30
MDTE1513-5R6M	5.6	±20%	40.0	35.0	29.0	3.90
MDTE1513-6R8M	6.8	±20%	37.0	32.0	27.0	4.20
MDTE1513-8R2M	8.2	±20%	33.0	29.0	26.0	5.74
MDTE1513-100M		±20%	30.0	27.0	25.0	7.00
MDTE1513-150M	15	±20%	25.5	21.0	22.0	7.50
MDTE1513-220M	22	±20%	22.0	19.0	17.0	13.86
MDTE1513-330M	33	±20%	19.0	16.0	14.0	22.20

Saturation Current will cause L to drop approximately 30%

Temperature Rise Current: The actual value of DC current when the temperature rise is $\Delta T=40^\circ\text{C}$

Soldering Reflow:

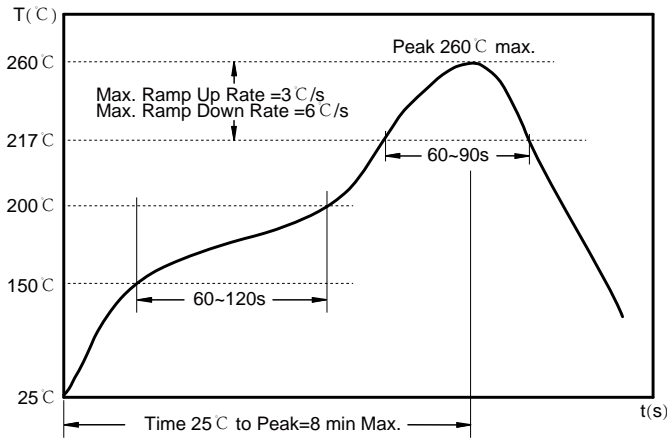

Preheat condition: 150 ~200 °C / 60~120 sec.
 Allowed time above 217 °C: 60~90 sec.
 Max temperature: 260 °C.
 Max time at max temperature: 10 sec.
 Allowed Reflow time: 2x max.

Packaging Information:

Tape Dimension:

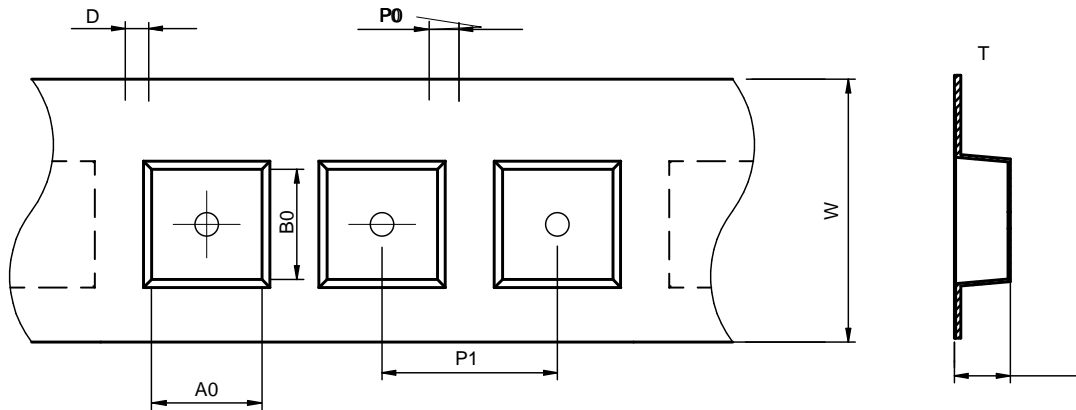

Series	A0 (mm)	B0 (mm)	D (mm)	P0 (mm)	P1 (mm)	W (mm)	K0 (mm)	E (mm)	T (mm)
MDTE1513	17.0±0.1	16.0±0.1	1.5±0.1	4.0±0.1	24.0±0.1	32.0±0.3	13.6±0.1	1.75±0.1	0.5±0.05

Peel force of top cover tape:

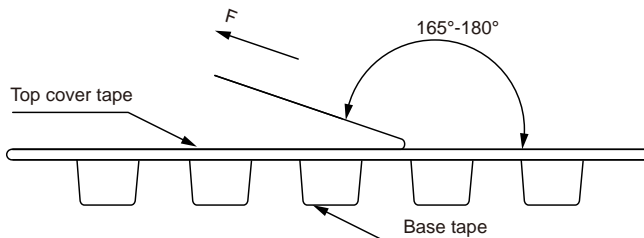

The peel force of top cover tape shall be between 0.1 to 1.3 N

Product Marking:

Marking	Printing (Inductance)
---------	-----------------------

Reel Dimension: [mm]

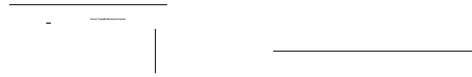

Packaging Quantity: