

MDTA Series

FEATURES

- High current, low DCR,
-
-
-
-
-

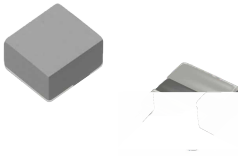

APPLICATION

-
-
- HVAC
-
-
-

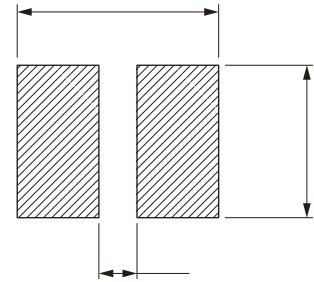
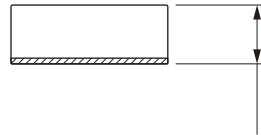
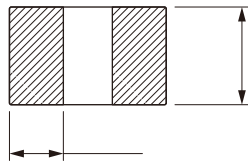
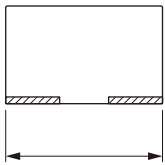

Part No	Inductance @ 100KHz/1V (μH)	Tolerance	Temperature Rise Current Typ. (A)	Temperature Rise Current Max. (A)	Saturation Current Typ. (A)	Saturation Current Max. (A)	DC Resistance Typ. (mΩ)	DC Resistance Max. (mΩ)
MDTA20121A-R10M		±20%					8	
MDTA20121A-R22M		±20%					16	22
MDTA20121A-R24M		±20%					17	
		±20%					24	
MDTA20121A-R47M		±20%					29	
MDTA20121A-R68M		±20%						
MDTA20121A-1R0M		±20%						
		±20%					76	
MDTA20121A-2R2M		±20%						



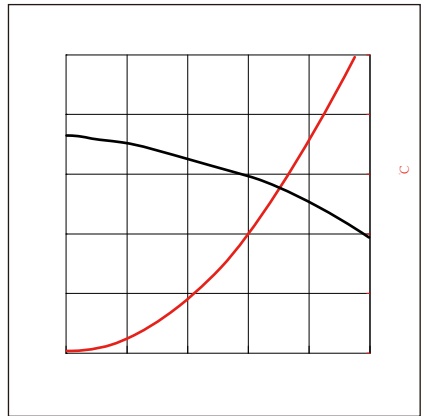
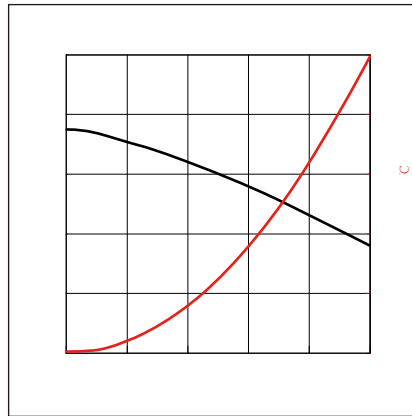
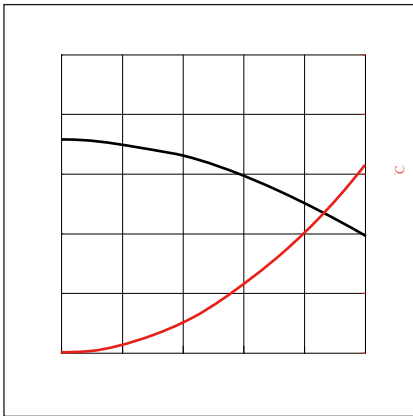
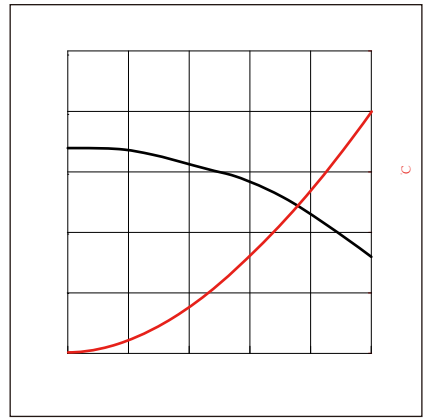
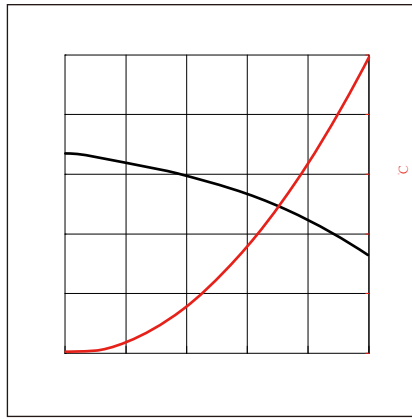
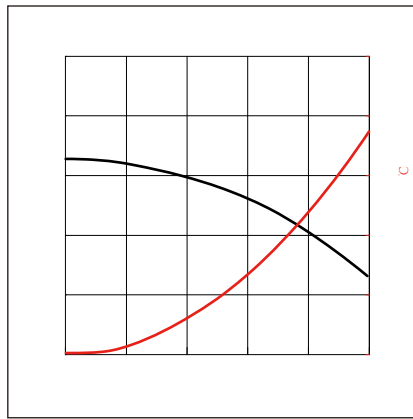
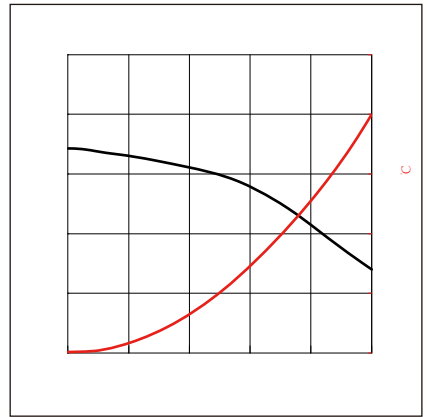
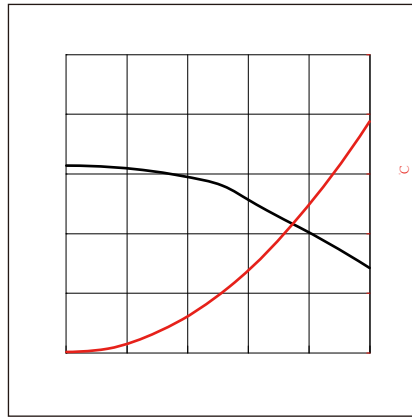
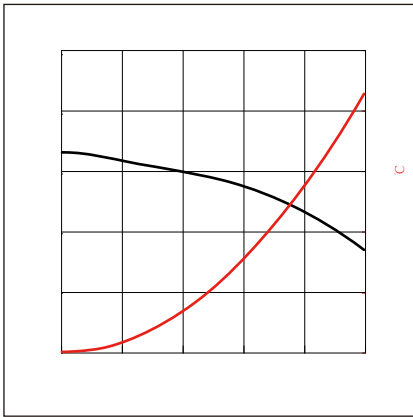

:

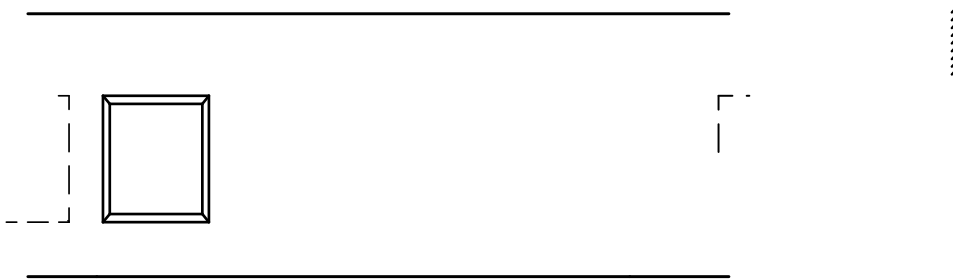

MDTA20121A	1.5±0.1	2.3±0.1	1.5±0.1	4.0±0.1	4.0±0.1	8.0±0.1	1.2±0.1	1.75±0.1	0.25±0.05

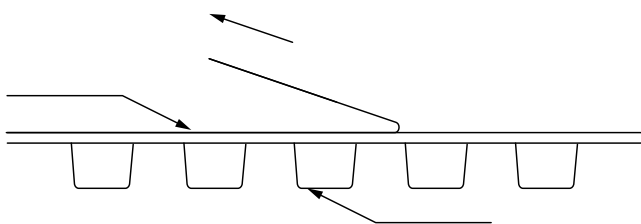

The peel force of top cover tape shall be between 0.1 to 0.98 N

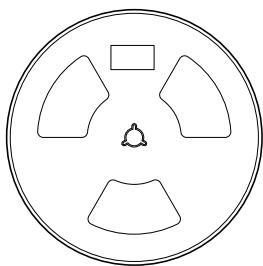
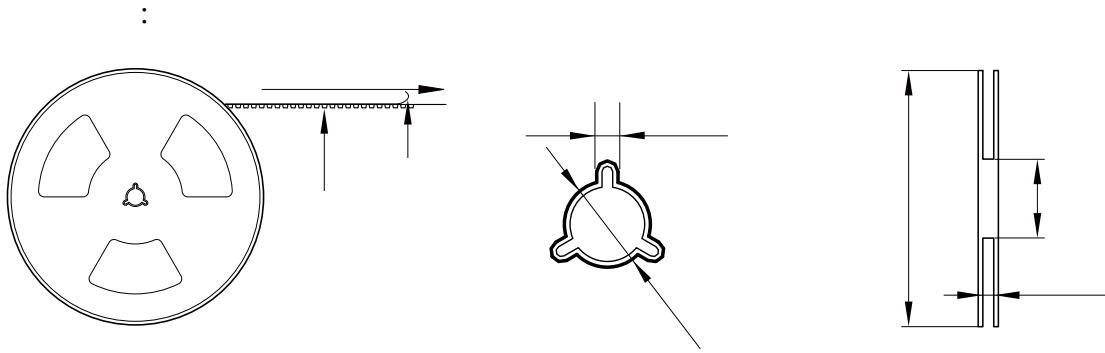

3000 Pcs/Reel

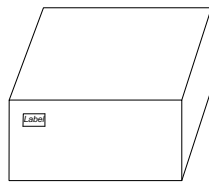

5 Reel /Inner box(15K Pcs)

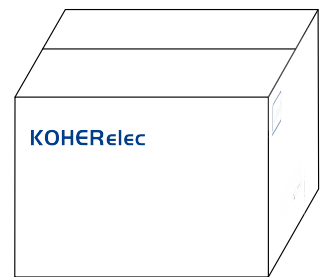

8 Inner box/Carton box(120K Pcs)

:

-
-
-
-
-
-
-
-
-