

MDE Series

Molding Power Inductors

Size 252010



FEATURES

- High saturation current realized by material properties
- Low DC resistance to achieve high conversion efficiency
- Low Profile.
- Magnetically shielded structure to accomplish high resolution in EMC protection.
-
- Operating temperature: -40 to +125 °C
- Quantity: 3000PCS

APPLICATION

-
-
-
-

Dimensions: [mm]

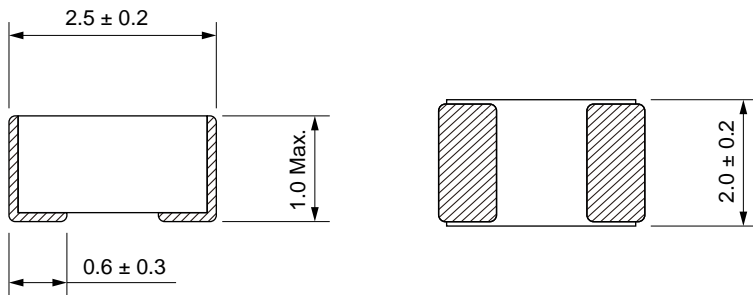

Land Pattern: [mm]

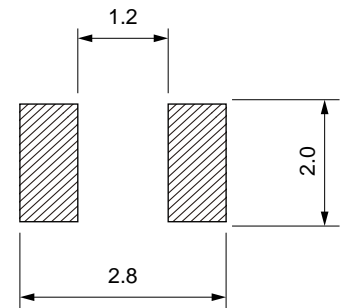

Electrical Properties:

Part No	Inductance @ 1MHz/1V (μH)	Tolerance	DC Resistance Typ. (mΩ)	DC Resistance Max. (mΩ)	Saturation Current Typ. (A)	Saturation Current Max. (A)	Temperature Rise Current Typ. (A)	Temperature Rise Current Max. (A)

Temperature rising current will cause the coil temperature approximate T40 °C
 Saturation current will cause to drop approximately 30%

Typical Electrical Characteristics:

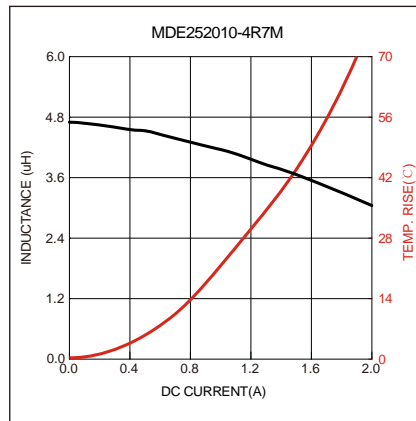
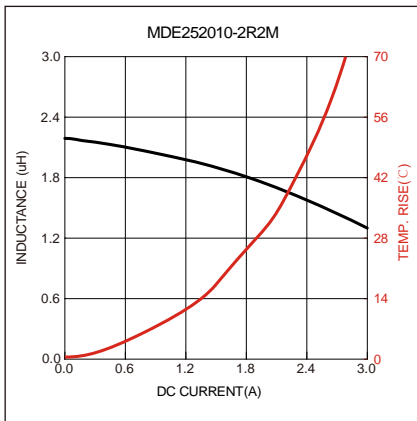
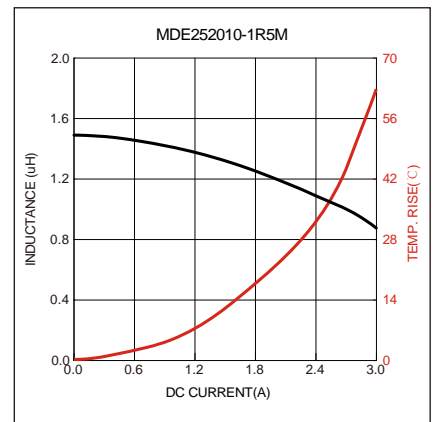
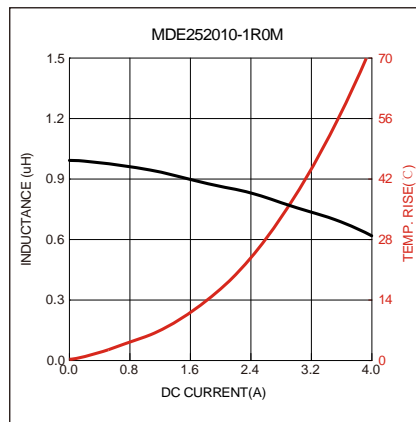
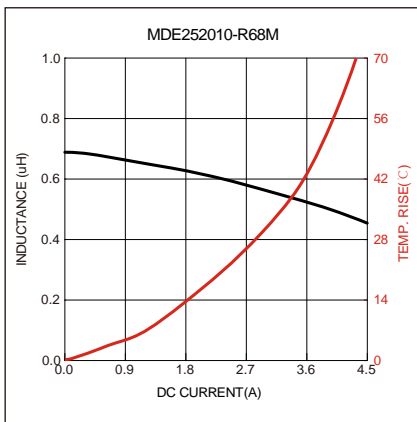
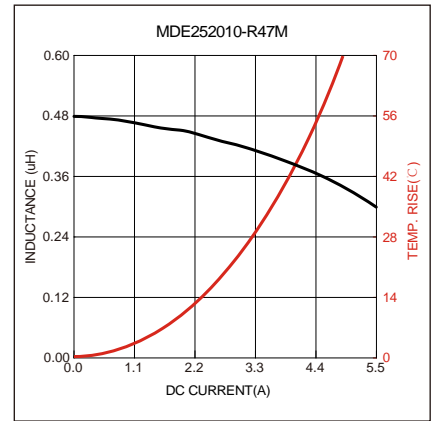
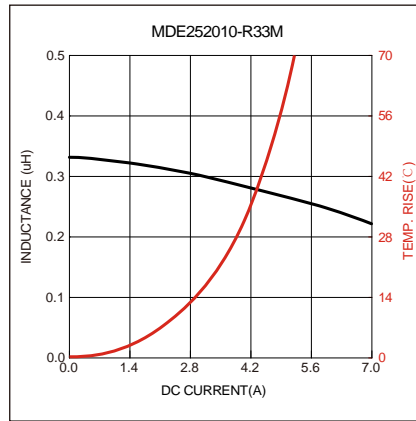
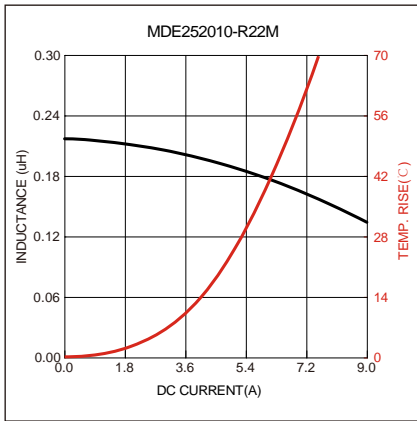

Soldering Reflow:

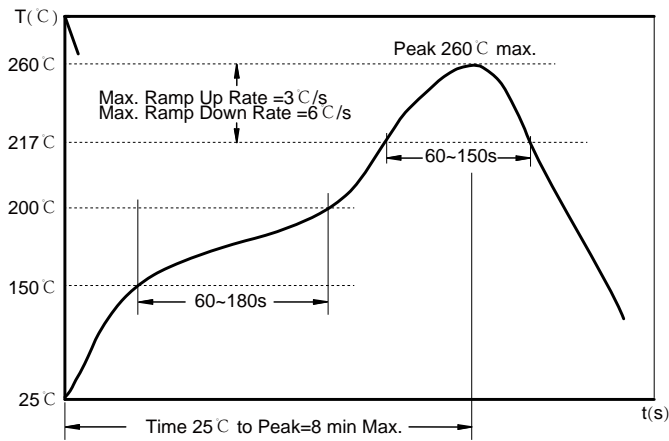

Preheat condition: 150 ~200 °C / 60~180 sec.

Allowed time above 217 °C : 60~150 sec.

Max temperature: 260 °C .

Packaging Information:

Tape Dimension:

Peel force of top cover tape:

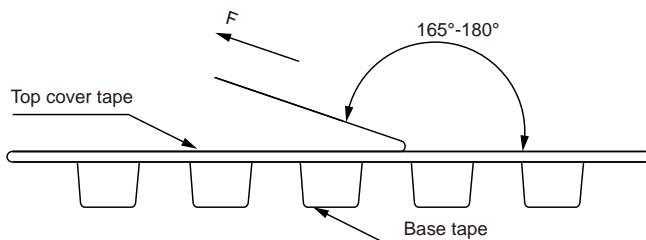

The peel force of top cover tape shall be between 0.1 to 1.3 N

Reel Dimension: [mm]

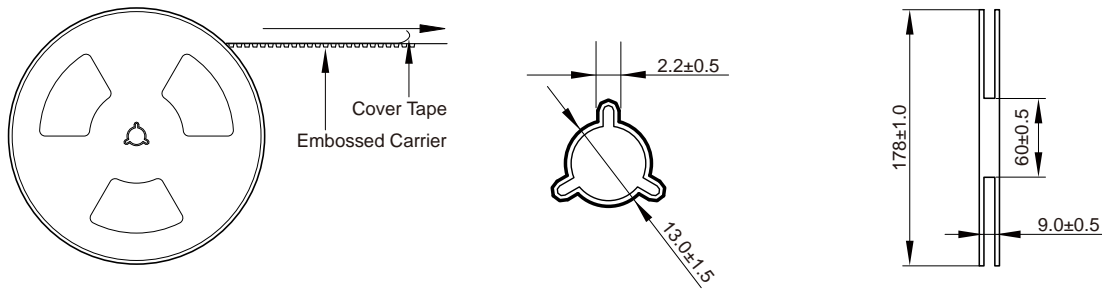

Packaging Quantity:

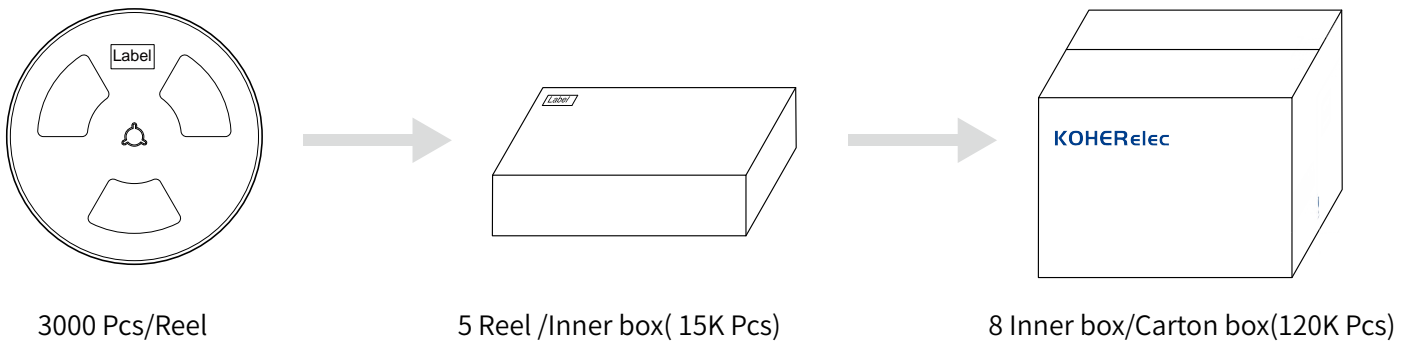

Cautions and Warnings:

Storage Conditions:

- The storage period is within 12 months after the completion of production. Be sure to follow the storage conditions (temperature: -5 to 35°C, humidity: 75% RH Max). If the storage period elapses, the soldering of the terminal electrodes may deteriorate. The warranty period is one year.
- Product should not be exposed to environment with high temperature, high humidity, dust, corrosive gas and etc.
- Products should be handled with care to avoid damage or contamination from perspiration and skin oils.
- Please always handle products carefully to prevent any damage caused by dropping down or inappropriate removing.

Operation Instructions:

- Self heating (temperature increase) occurs when the power is turned ON, so the tolerance should be sufficient for the set thermal design.
- Before soldering, be sure to preheat components. The preheating temperature should be set so that the temperature difference between the solder temperature and chip temperature does not exceed 150°C.
- Soldering corrections after mounting should be within the range of the conditions determined in the specifications. If overheated, a short circuit, performance deterioration, or lifespan shortening may occur.
- Generally, Koher might not be familiar with either customer's specific application or actual requests as customer does. As a result customer shall be responsible for checking and confirming whether Koher product with the performance described in the product specification is suitable for using in customer's particular application or not.