

MDE Series

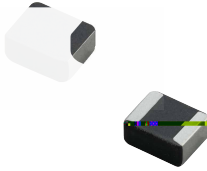

FEATURES

-
-
-
-
-

APPLICATION

-
-
-
-

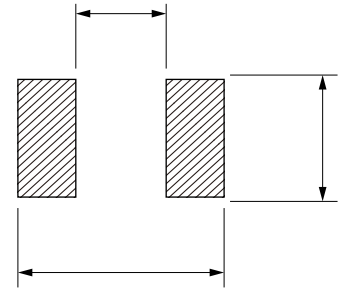
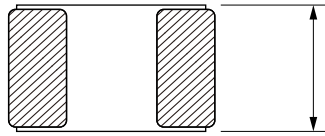
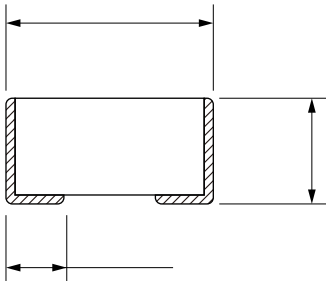

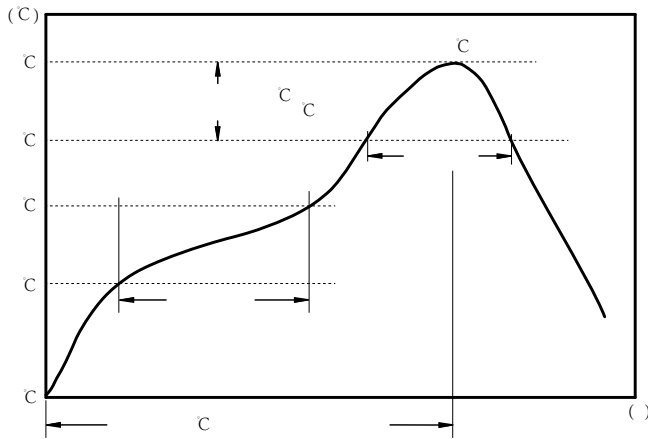

c
c
c
c

:

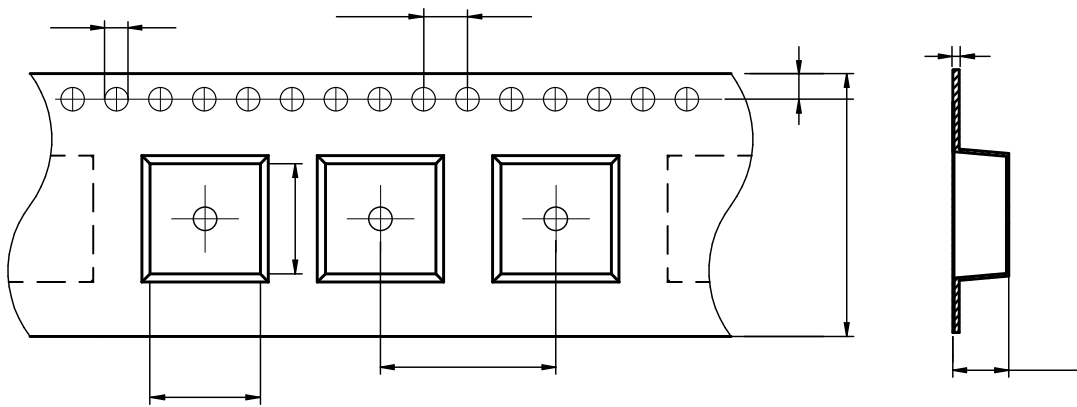

MDE201610S	1.82 ± 0.05	2.23 ± 0.05	1.55 ± 0.05	4.0 ± 0.1	4.0 ± 0.1	8.0 ± 0.3	1.15 ± 0.05	1.75 ± 0.1	0.22 ± 0.05

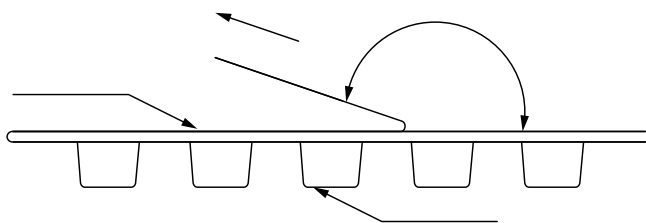

The peel force of top cover tape shall be between 0.1 to 1.3 N

:

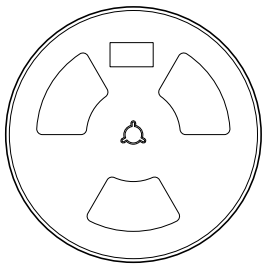
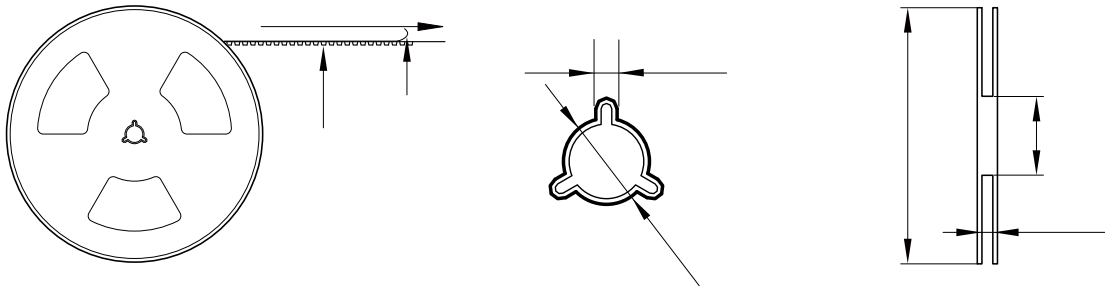

3000 Pcs/Reel

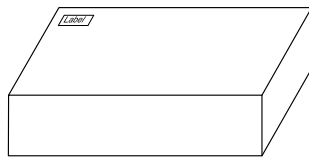

5 Reel /Inner box(15K Pcs)

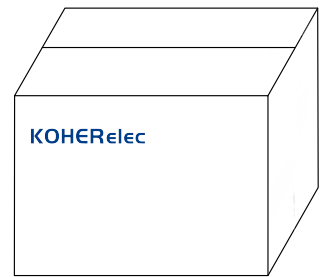

8 Inner box/Carton box(120K Pcs)

:

-
-
-
-
-
-
-
-
-