

Saturation

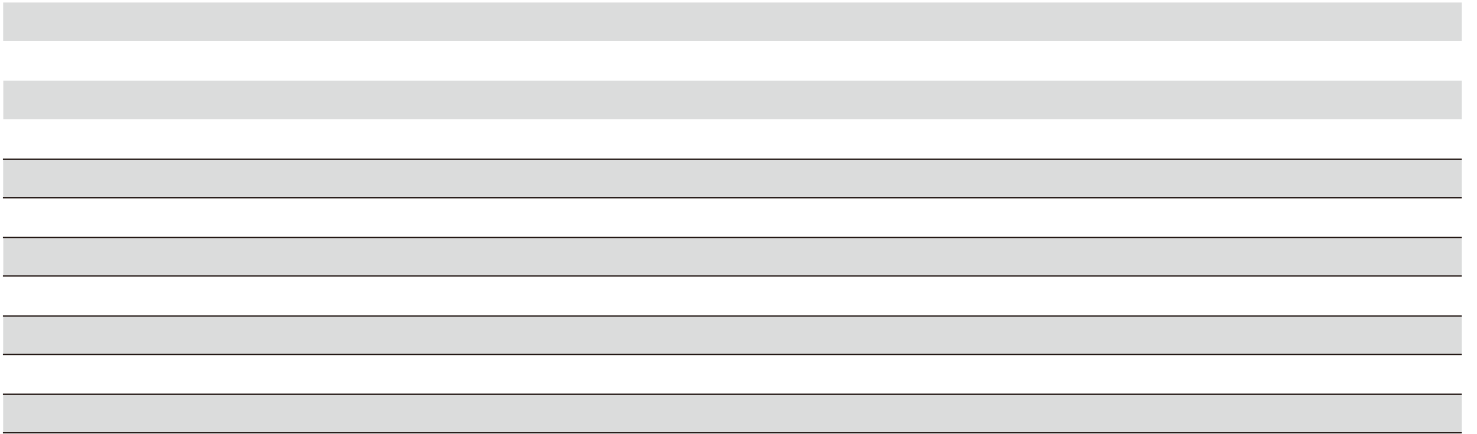

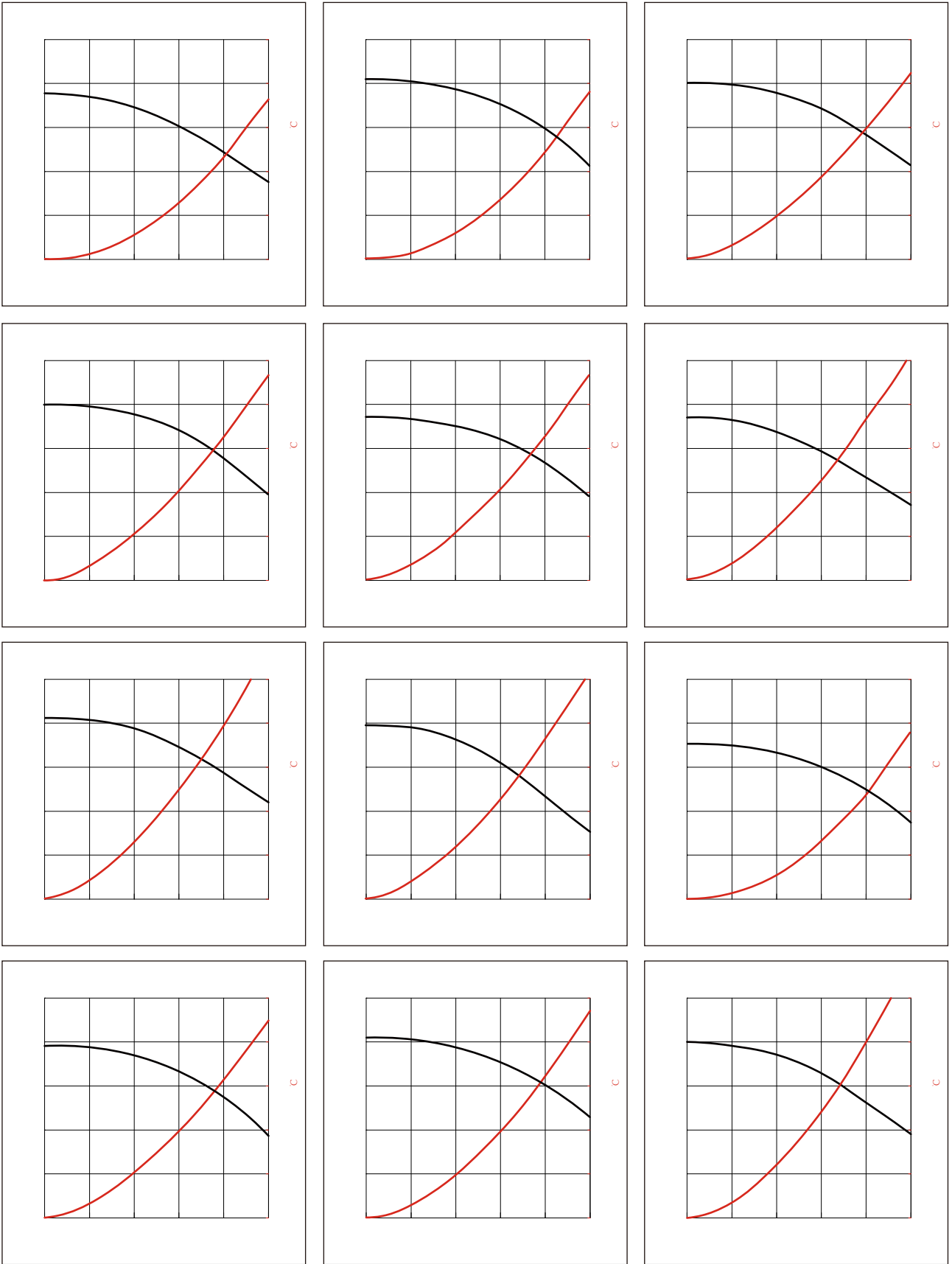

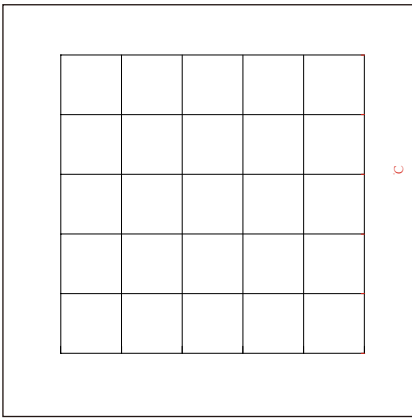

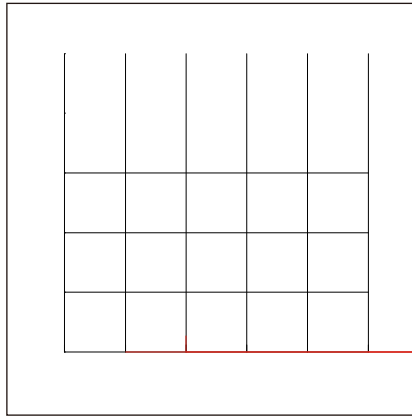
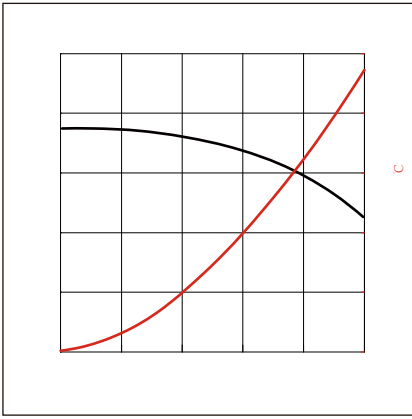
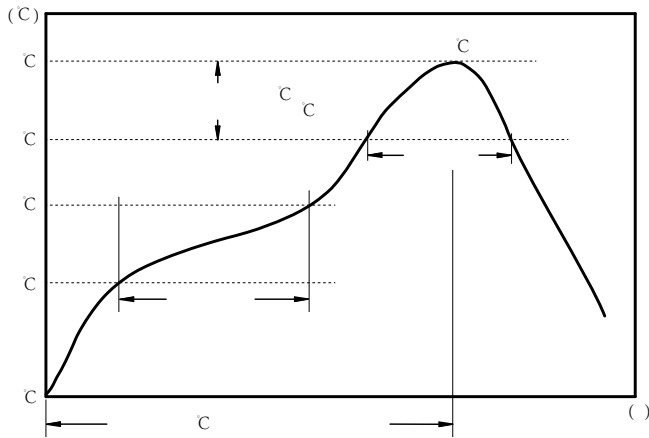

c
c
c

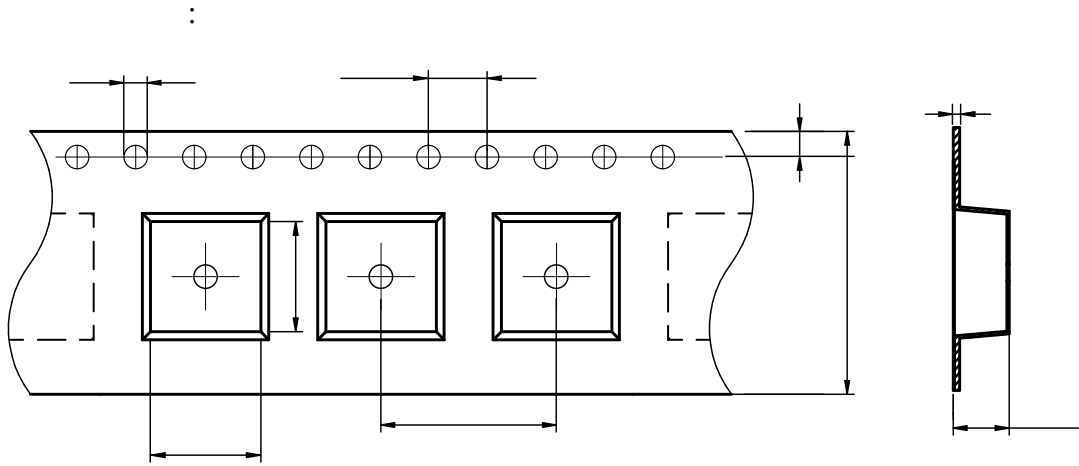

MDA7030	7.0±0.1	7.7±0.1	1.5±0.1	4.0±0.1	12.0±0.1	16.0±0.3	3.4±0.1	1.75±0.1	0.35±0.05

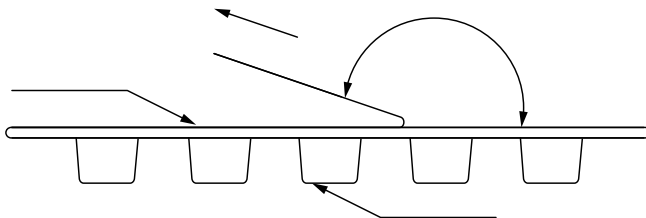

The peel force of top cover tape shall be between 0.1 to 1.3 N

Marking	K+Printing (Inductance+period)
---------	--------------------------------

:

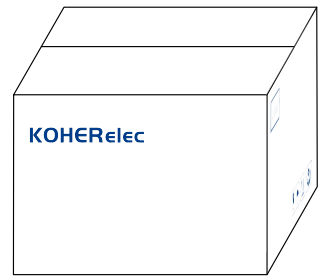
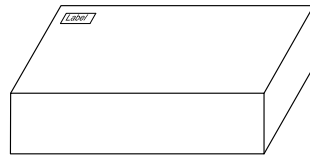
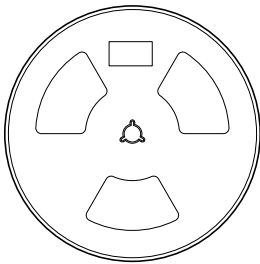
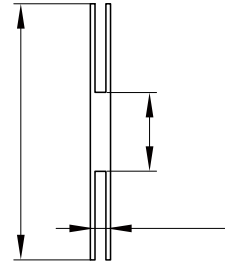
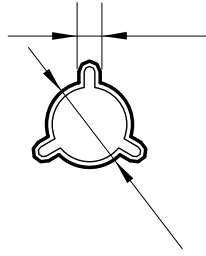
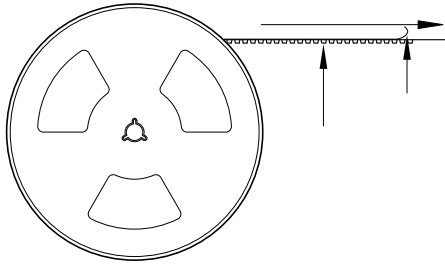

1000 Pcs/Reel

2 Reel /Inner box(2000 Pcs)

3 Inner box/Carton box(6K Pcs)

:

-
-
-
-
-
-
-
-
-
-