

Typical Electrical Characteristics:

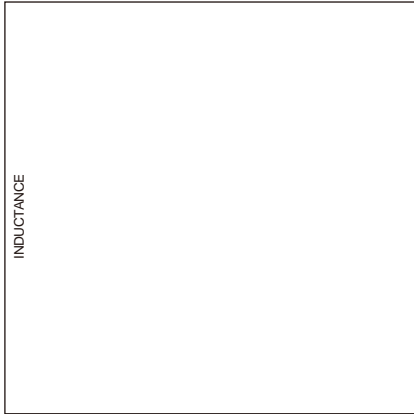

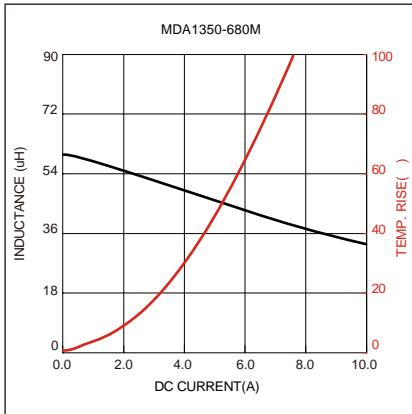

Soldering Reflow:

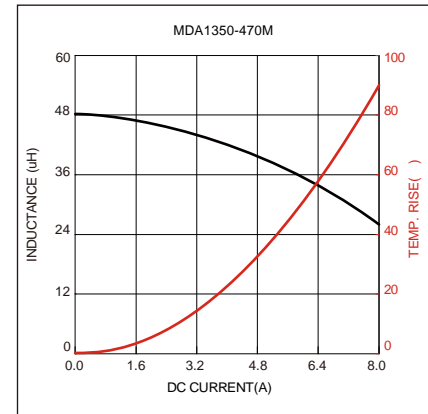
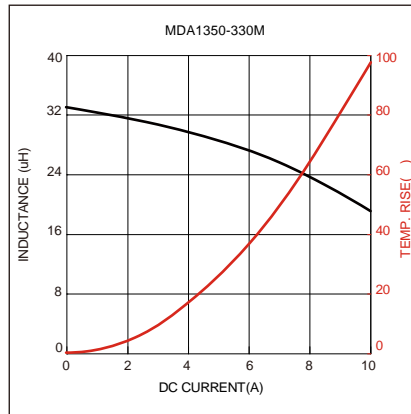
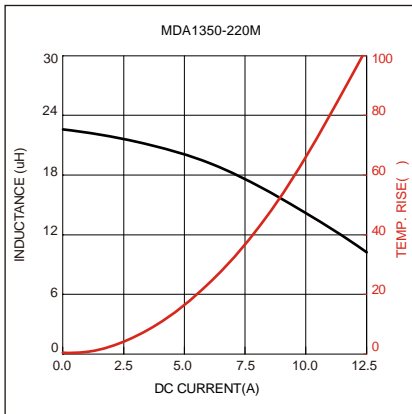
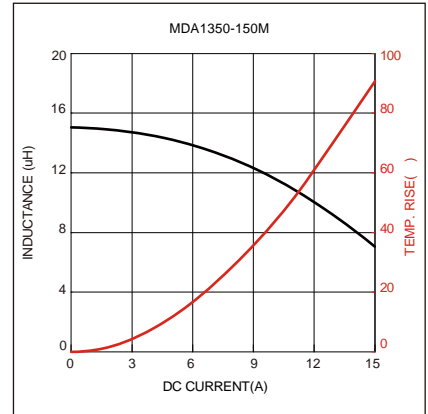
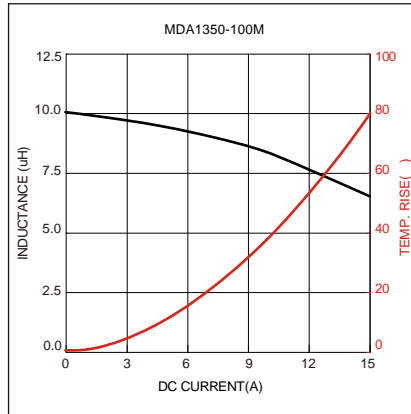
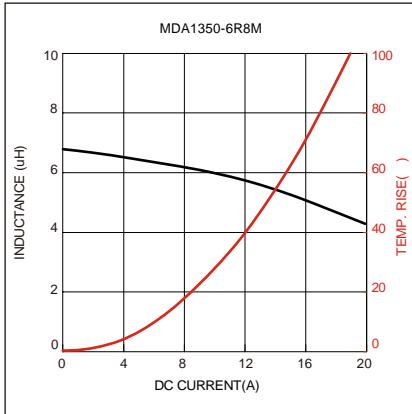
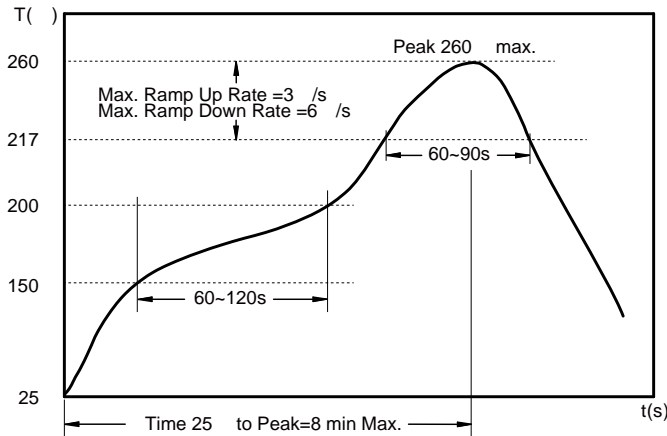

Preheat condition: 150 ~200 °C / 60~120 sec.
 Allowed time above 217 °C : 60~90 sec.
 Max temperature: 260 °C .
 Max time at max temperature: 10 sec.
 Allowed Reflow time: 2x max.

Packaging Information:

Tape Dimension :

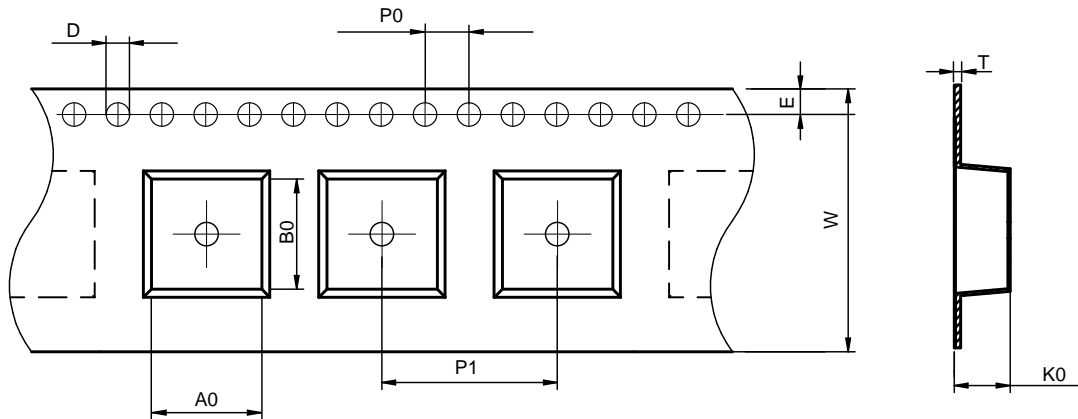

Series	A0 (mm)	B0 (mm)	D (mm)	P0 (mm)	P1 (mm)	W (mm)	K0 (mm)	E (mm)	T (mm)
MDA1350	13.1±0.1	14.0±0.1	1.5±0.1	4.0±0.1	16.0±0.1	24.0±0.3	5.4±0.1	1.75±0.1	0.50±0.05

Peel force of top cover tape:

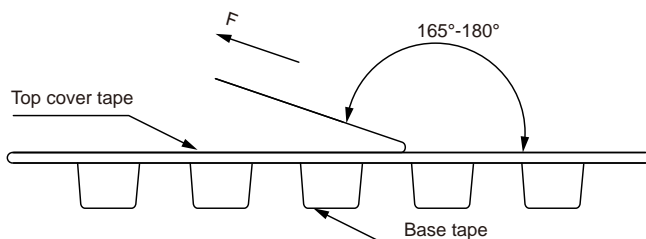

The peel force of top cover tape shall be between 0.1 to 1.3 N

Product Marking:

Marking	KH+Printing (Inductance+period)
---------	---------------------------------

Reel Dimension : [mm]

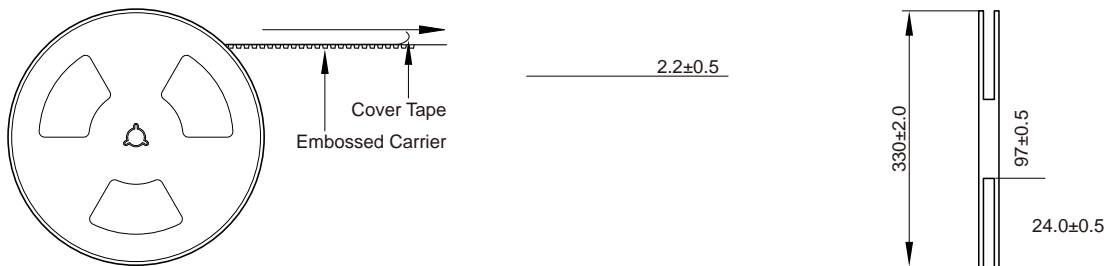

Packaging Quantity:

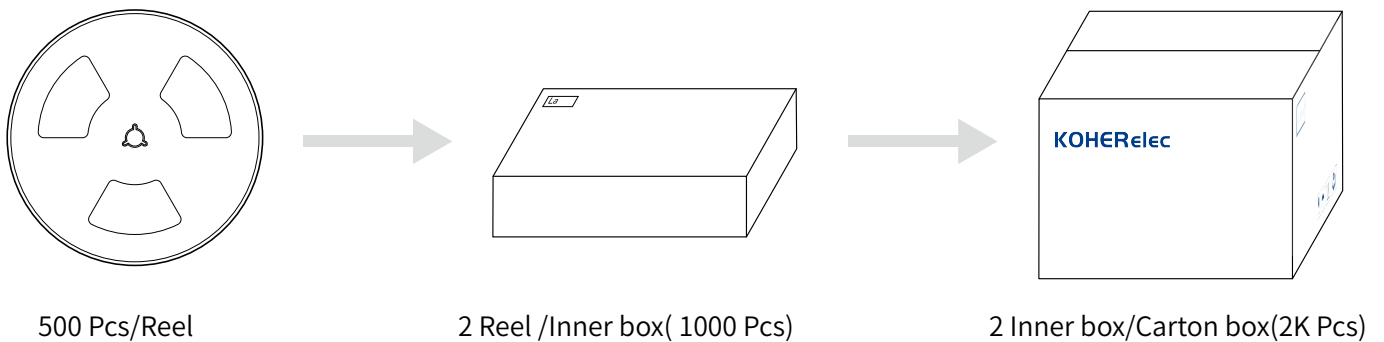

Cautions and Warnings:

Storage Conditions :

- The storage period is within 12 months after the completion of production. Be sure to follow the storage conditions (temperature: -5 to 35°C , humidity: 75% RH Max).If the storage period elapses, the soldering of the terminal electrodes may deteriorate.The warranty period is one year.
- Product should not be exposed to environment with high temperature, high humidity, dust, corrosive gas and etc.
- Products should be handled with care to avoid damage or contamination from perspiration and skin oils.
- Please always handle products carefully to prevent any damage caused by dropping down or inappropriate removing.

Operation Instructions:

- Self heating (temperature increase) occurs when the power is turned ON, so the tolerance should be sufficient for the set thermal design.
- Before soldering, be sure to preheat components.The preheating temperature should be set so that the temperature difference between the solder temperature and chip temperature does not exceed 150°C .
- Soldering corrections after mounting should be within the range of the conditions determined in the specifications.If overheated, a short circuit, performance deterioration, or lifespan shortening may occur.
- Generally, Koher might not be familiar with either customer's specific application or actual requests as customer does.As a result customer shall be responsible for checking and confirming whether Koher product with the performance described in the product specification is suitable for using in customer's particular application or not.