

FBHA Series



FEATURES

- Noise reduction solution for power line.
- Compared to the FBA series, has low direct current resistance for compatibility with large currents, optimal for low power consumption.
- Various frequency characteristics with 2 materials of different features for countermeasures against everything from general signals to high-speed signals.
- Performs well even in signal lines where low direct current resistance is required.
- AEC-Q200 qualified.
- Operating temperature: -55 to +150 °C (including self-temperature rise)
- Quantity: 4000PCS

APPLICATION

- Power line filter for body controls, and car multimedia etc.

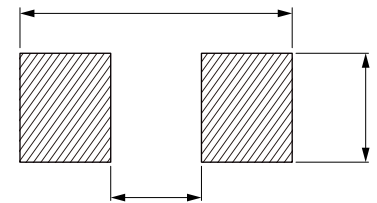
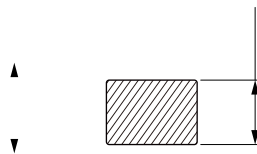
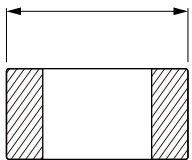

Part No	Impedance @ 100MHz (Ω)	Tolerance	DC Resistance (Ω)	Temperature Rise Current (mA)
FBHA0805-220-602R	22	±25%	0.01	6000
FBHA0805-300-302R	30	±25%	0.04	3000
FBHA0805-300-602R	30	±25%	0.01	6000
FBHA0805-800-302R	80	±25%	0.04	3000
FBHA0805-101-102R	100	±25%	0.15	1000
FBHA0805-101-502R	100	±25%	0.02	5000
FBHA0805-121-202R	120	±25%	0.10	2000
FBHA0805-121-302R	120	±25%	0.04	3000
FBHA0805-151-202R	150	±25%	0.10	2000
FBHA0805-221-202R	220	±25%	0.10	2000
FBHA0805-221-302R	220	±25%	0.04	3000
FBHA0805-301-102R	300	±25%	0.20	1000
FBHA0805-331-252R	330	±25%	0.05	2500
FBHA0805-471-102R	470	±25%	0.20	1000
FBHA0805-601-102R	600	±25%	0.20	1000
FBHA0805-601-202R	600	±25%	0.10	2000
FBHA0805-102-102R	1000	±25%	0.20	1000
FBHA0805-102-152R	1000	±25%	0.15	1500

△

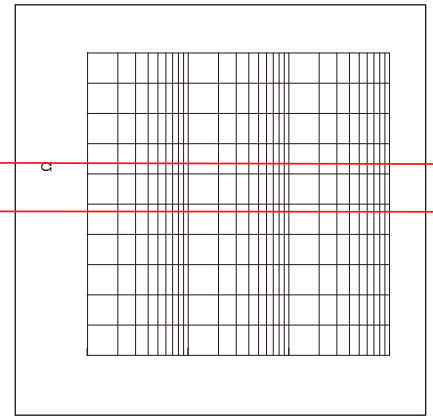
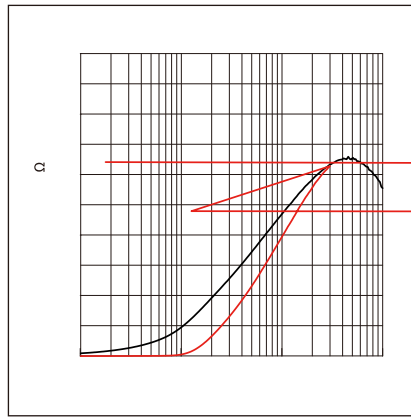
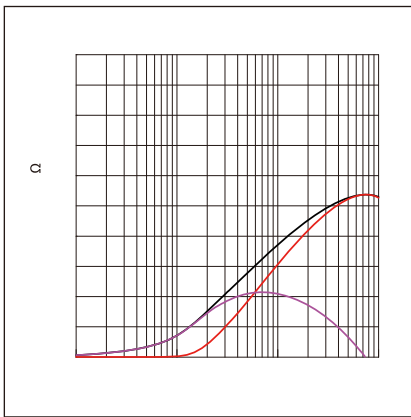
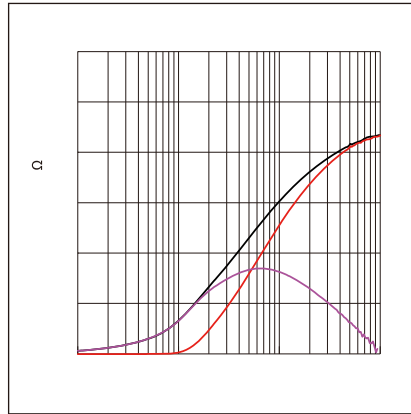

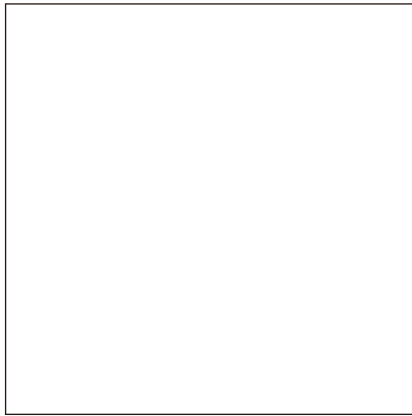
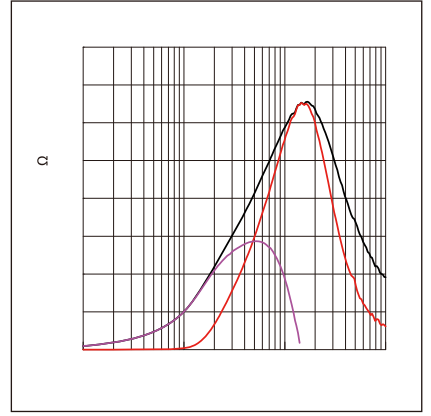
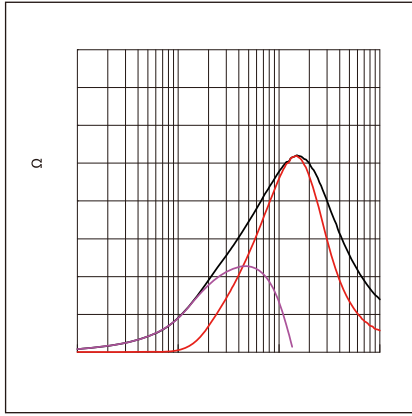

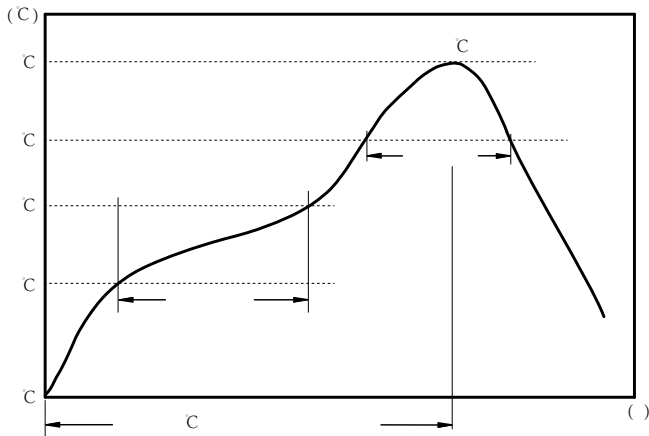

C
C
C

:

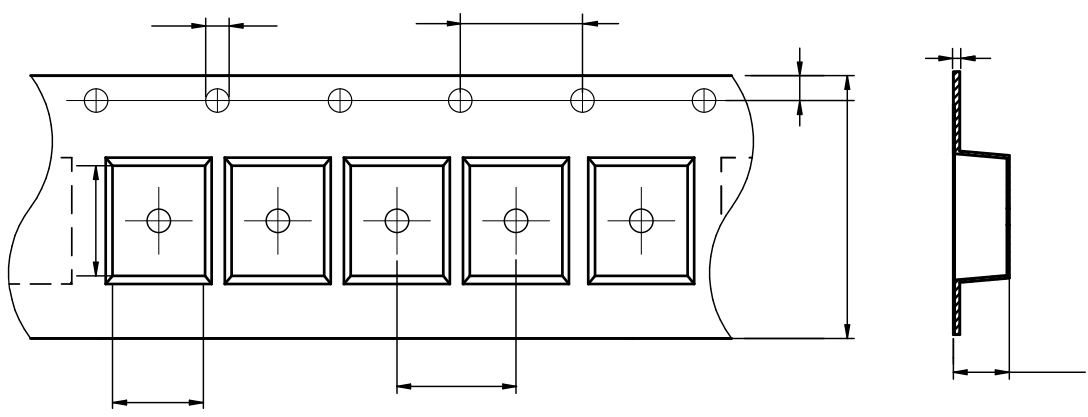

FBHA0805	1.30±0.05	2.10±0.05	1.5±0.1	4.0±0.1	4.0±0.1	8.0±0.3	0.95±0.05	1.75±0.1	0.95±0.05

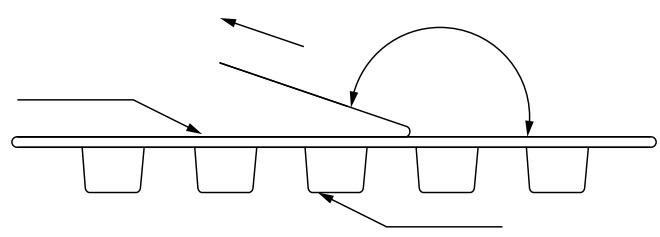

The peel force of top cover tape shall be between 0.14 to 0.58 N

