

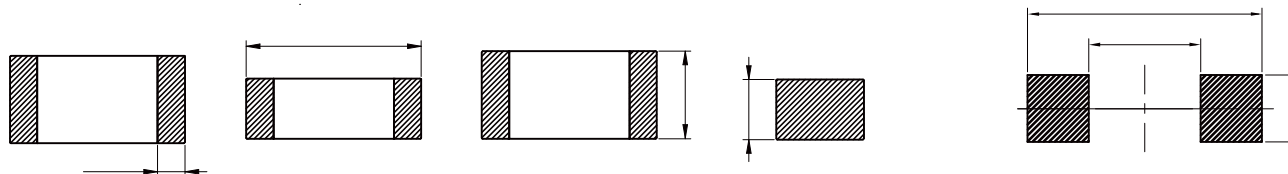

- Noise reduction solution for general signal line.
- Various frequency characteristics with 2 materials of different features for countermeasures against everything from general signals to high-speed signals
- AEC-Q200 qualified
- Operating temperature: -55° to +150°C
- Quantity: 3000pcs

- Signal line filter for body controls, and car multimedia etc.



| Part No | Z @ 100 MHz (Ω) | Tolerance | R _{DC} (Ω) | I _R (mA) |
|------------------|-----------------|-----------|---------------------|---------------------|
| FBA1206-260-501R | | ±25% | 0.20 | 500 |
| FBA1206-310-501R | | ±25% | 0.20 | 500 |
| FBA1206-420-501R | | ±25% | 0.20 | 500 |
| FBA1206-500-501R | | ±25% | 0.20 | 500 |
| FBA1206-700-501R | | ±25% | 0.20 | 500 |
| FBA1206-900-501R | | ±25% | 0.20 | 500 |
| FBA1206-121-901R | | ±25% | 0.15 | 900 |
| FBA1206-151-901R | | ±25% | 0.15 | 900 |
| FBA1206-221-701R | | ±25% | 0.35 | 700 |
| FBA1206-301-701R | | ±25% | 0.35 | 700 |
| FBA1206-471 | | ±25% | 0.35 | 400 |
| i | | ±25% | 0.40 | 400 |

I_R referring to 20K self-heating above ambient temperature

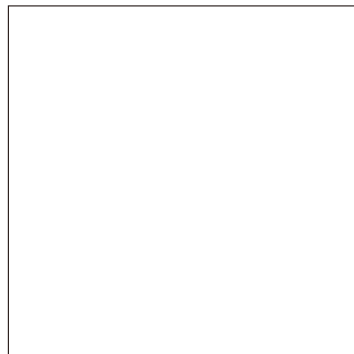
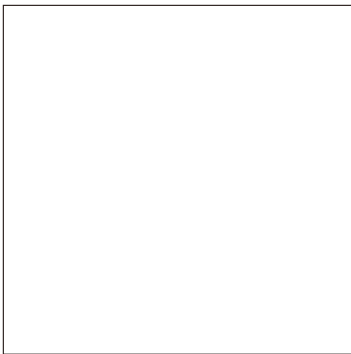
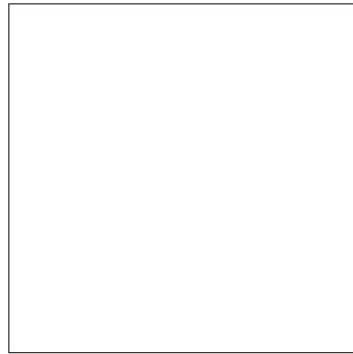
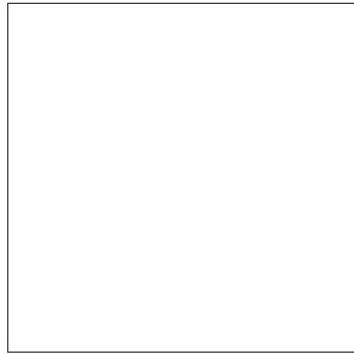
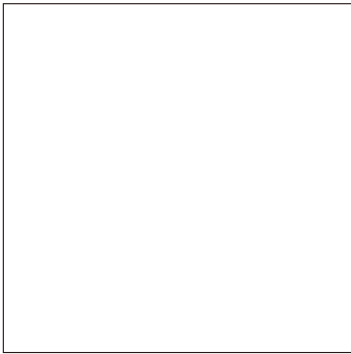
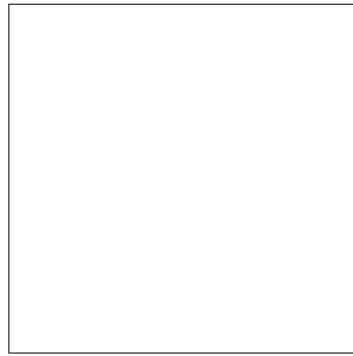
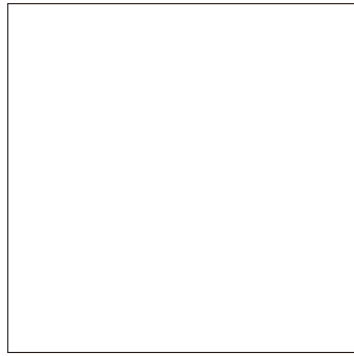
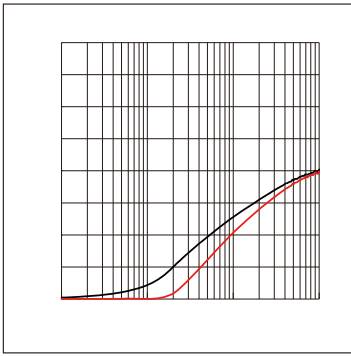

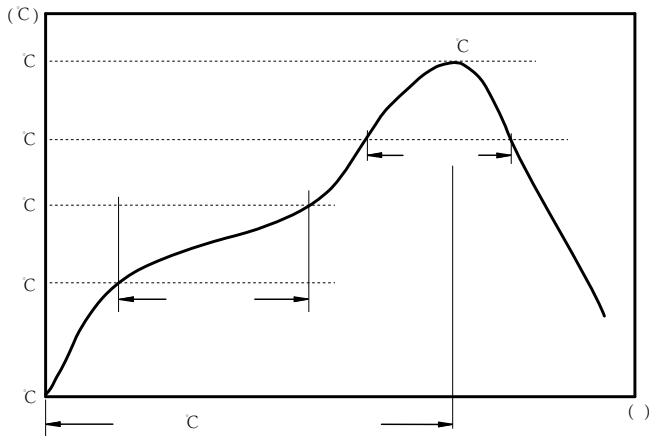

c
c
c

:

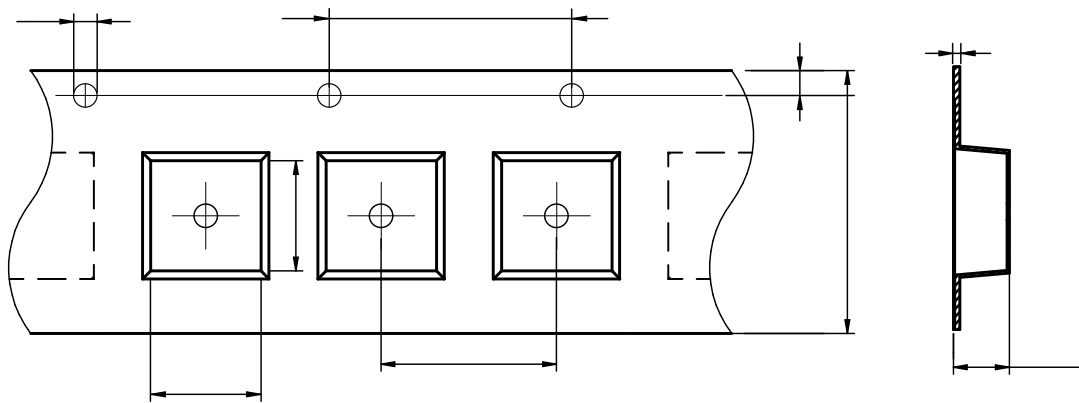

| | | | | | | | | | |
|---------|-----------|-----------|----------|----------|----------|----------|-----------|-----------|-----------|
| FBA1206 | 1.75±0.10 | 3.35±0.10 | 1.5±0.10 | 4.0±0.10 | 4.0±0.10 | 8.0±0.10 | 1.25±0.10 | 1.75±0.10 | 0.23±0.05 |
|---------|-----------|-----------|----------|----------|----------|----------|-----------|-----------|-----------|

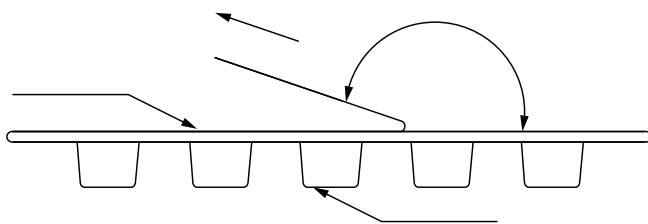

The peel force of top cover tape shall be between 0.14 to 0.58 N

:

