

FBA Series

FEATURES



- Quantity: 4000pcs

APPLICATION

-

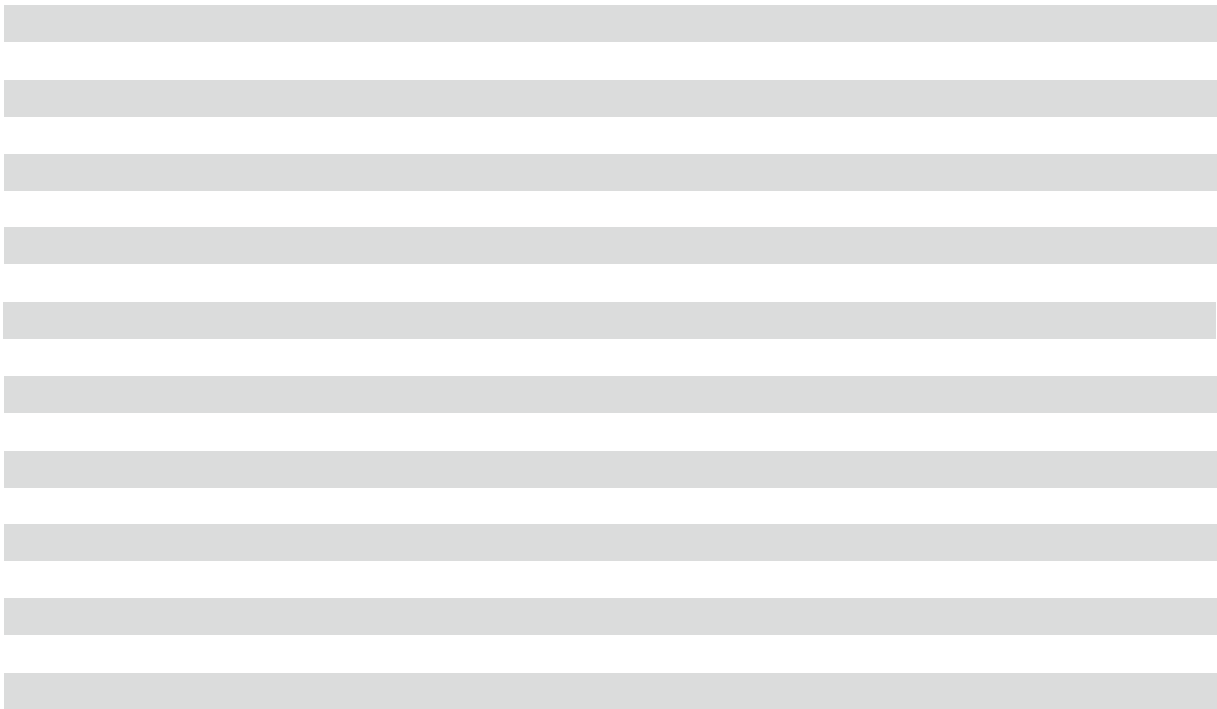
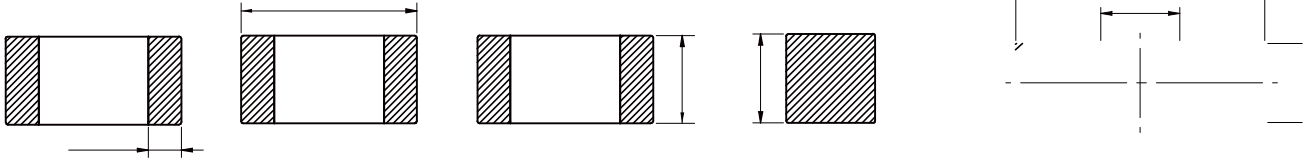

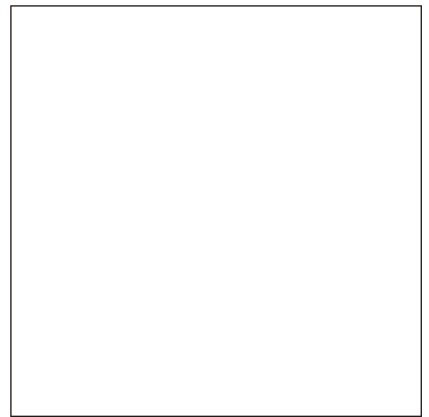
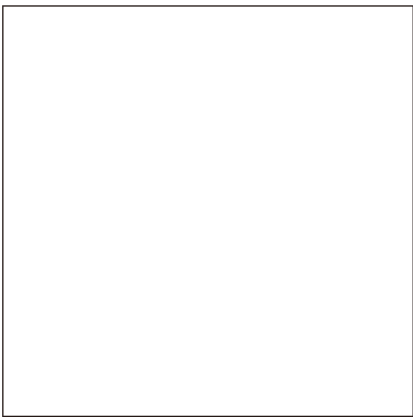
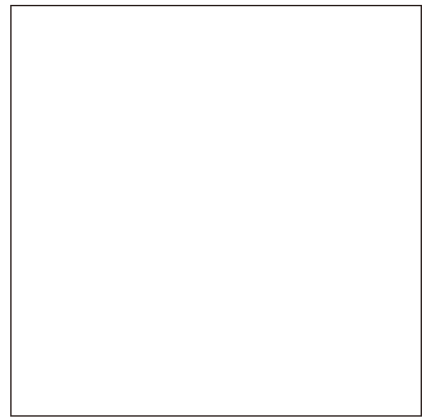
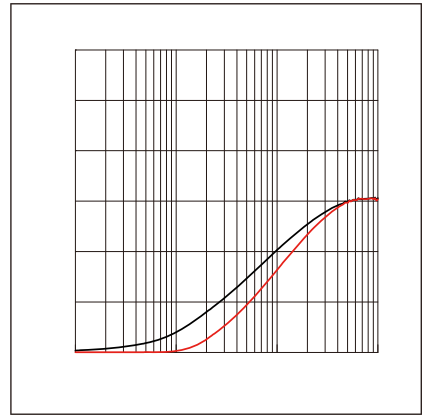
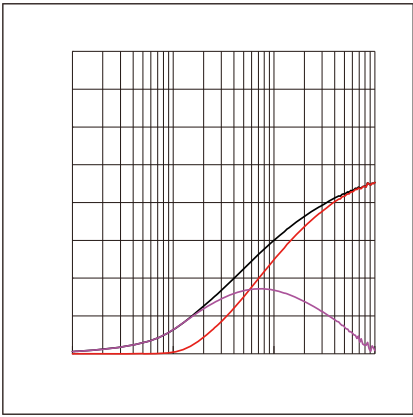

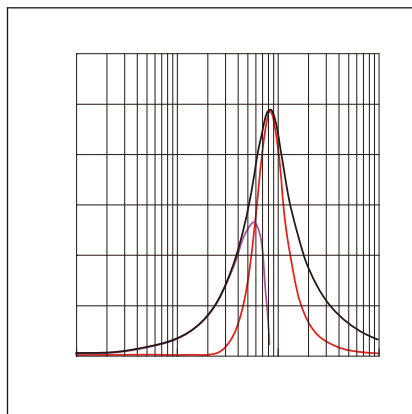
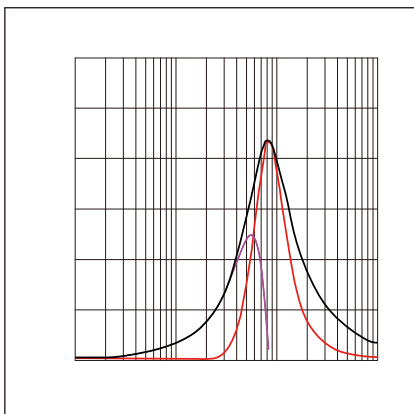
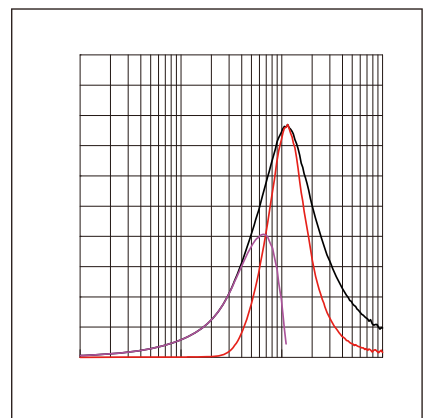
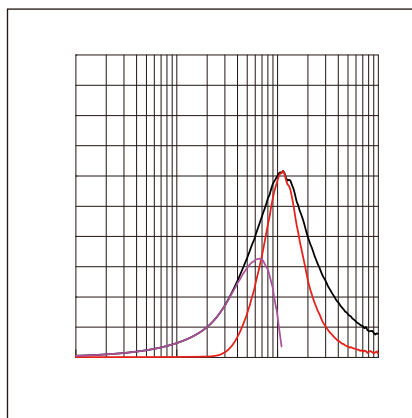
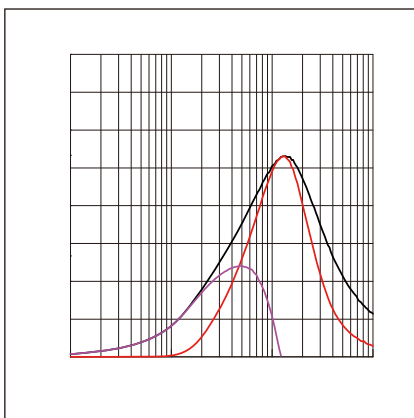
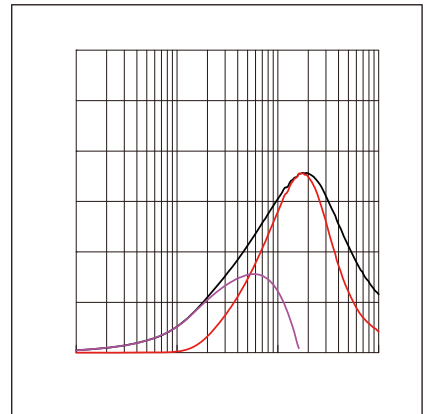
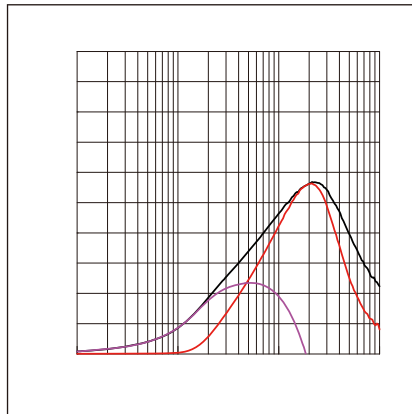
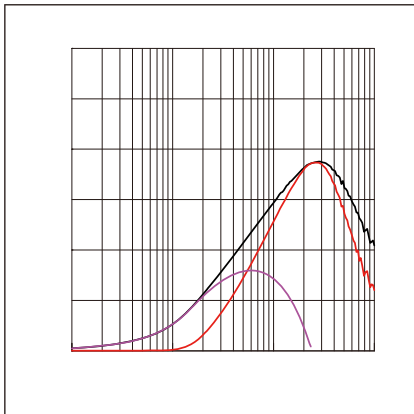

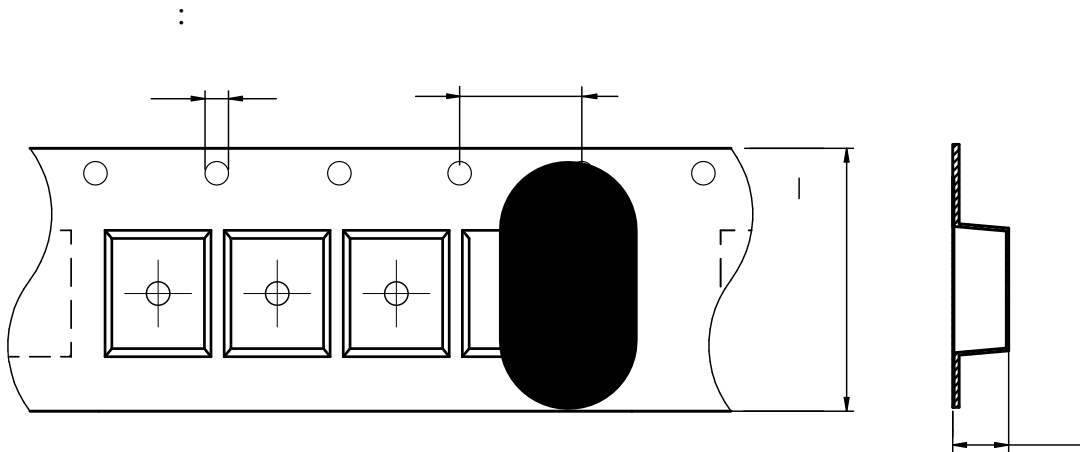

FBA0603	0.96 ± 0.05	1.8 ± 0.05	1.5 ± 0.1	4.0 ± 0.1	4.0 ± 0.1	8.0 ± 0.1	0.95 ± 0.05	1.75 ± 0.1	0.95 ± 0.05
---------	-----------------	----------------	---------------	---------------	---------------	---------------	-----------------	----------------	-----------------

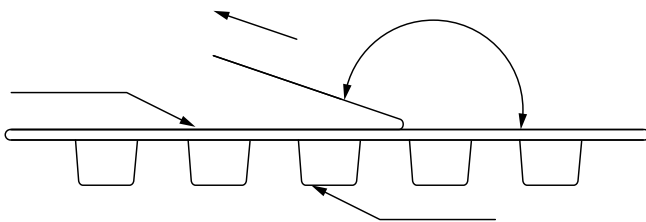

The peel force of top cover tape shall be between 0.14 to 0.58 N

:

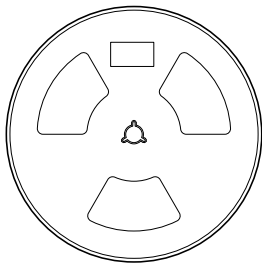
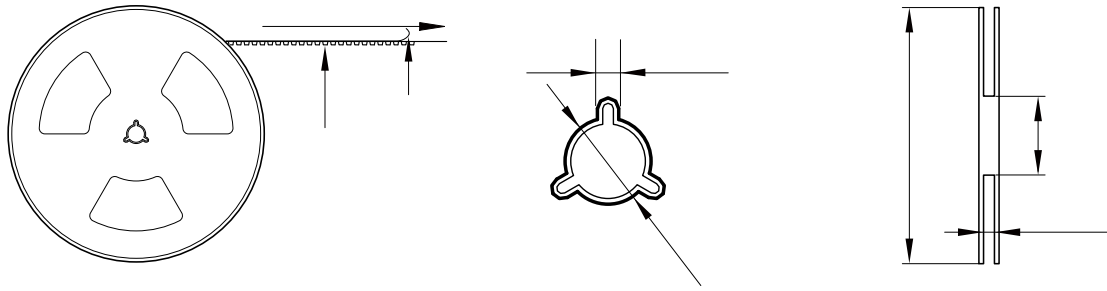

4000 Pcs/Reel

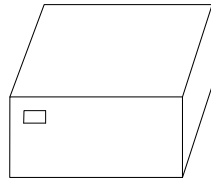

5 Reel /Inner box(20K Pcs)

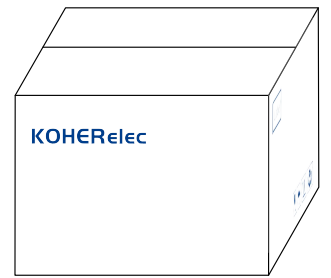

8 Inner box/Carton box(160K Pcs)

:

-
-
-
-
-
-
-
-
-
-