

# ACMV Series

## FEATURES

- 
- : °C °C
- 
- 

## APPLICATION

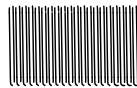

:

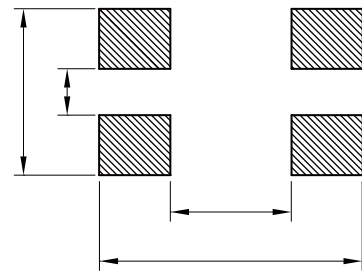

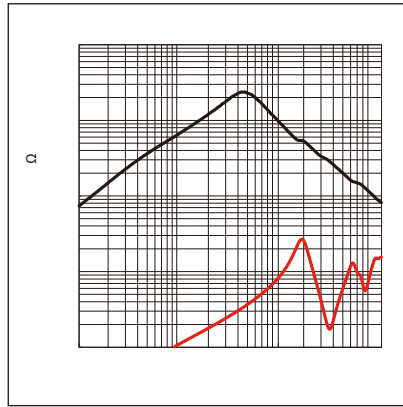
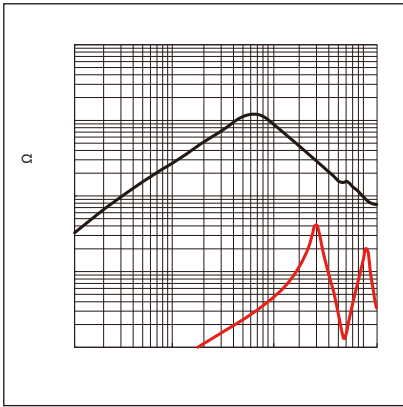

°C

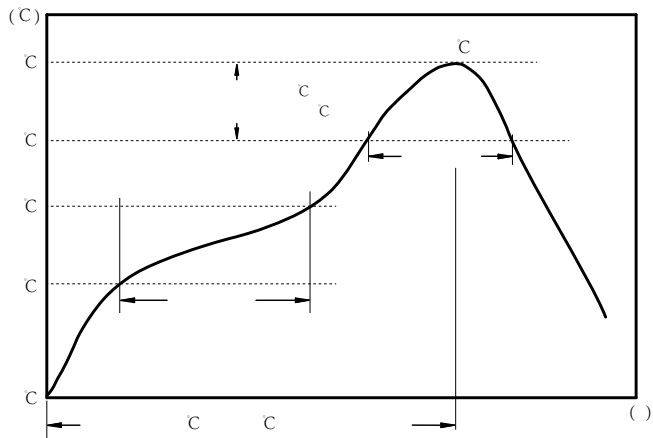

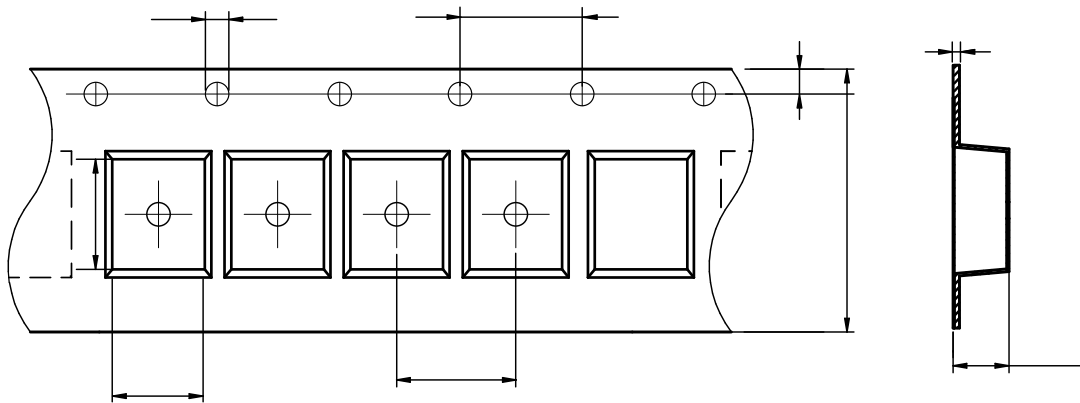

:



ACMV4532	$3.5 \pm 0.1$	$5.1 \pm 0.1$	$1.5 \pm 0.1$	$4.0 \pm 0.1$	$8.0 \pm 0.1$	$12.0 \pm 0.3$	$3.1 \pm 0.1$	$1.75 \pm 0.1$	$0.4 \pm 0.1$
----------	---------------	---------------	---------------	---------------	---------------	----------------	---------------	----------------	---------------

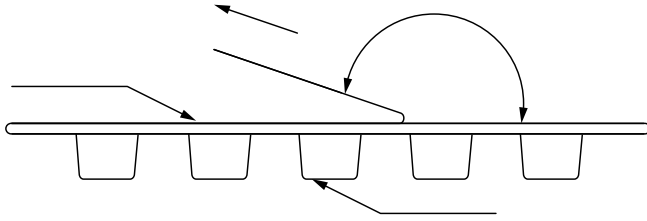

The peel force of top cover tape shall be between 0.1 to 1.3 N

:

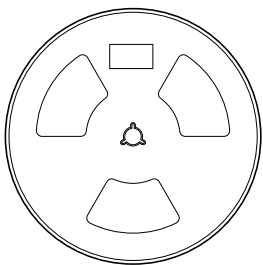
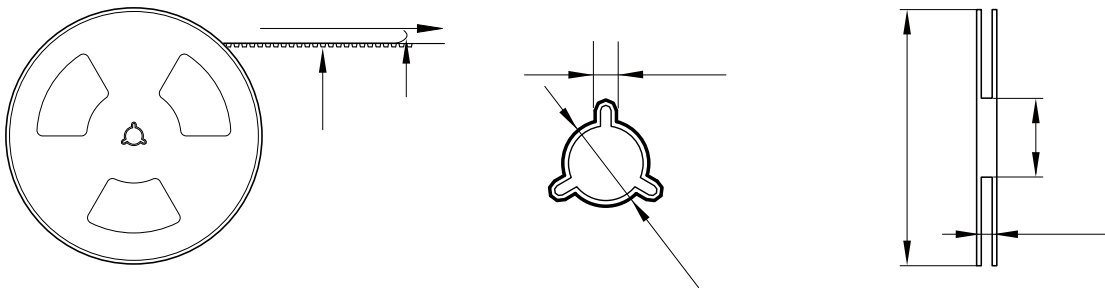

2500 Pcs/Reel

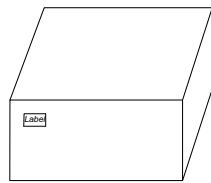

3 Reel /Inner box( 7500 Pcs)

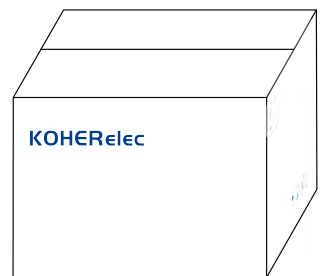

3 Inner box/Carton box(22.5K Pcs)

:

•

•

•

•

•

•

•

•

•

•

•